

# manual

## linea pb

The Linea PB, designed by and named in recognition of Piero Bambi, refashions the technical and stylistic workings of the Linea Classic, La Marzocco's industry icon introduced to the marketplace over 20 years ago. In addition to distinctive La Marzocco features, the Linea PB is equipped with exclusive, user-friendly interface software that gives the barista control over boiler temperature, brewing volume, hot water tap dose and other options, ensuring a new level of performance and reliability. The machine's lower profile and increased work area make it practical, without abandoning world renown Italian design.



**la marzocco**  
handmade in florence

# linea pb

Operating Manual V4.1 - 08/2020  
MAN.10.1.03

## Chapters

1. General Warnings and Safety Specifications	page 3
2. Definition of Available Models	page 8
3. Installation	page 11
4. Machine Operation and Coffee Preparation	page 17
5. Dispensing Steam and Hot Water	page 20
6. Maintenance and Periodic Cleaning Operations	page 21
7. De-commissioning and Demolition	page 23
8. Mandatory Maintenance and Check-up Operations	page 24
9. Precision Scale	page 25
10. Software Programming Guide	page 26

certifications available:



## la marzocco

handmade in florence

La Marzocco S.r.l.

Via La Torre 14/H  
Località La Torre  
50038 Scarperia e San Piero  
(Firenze) - ITALIA

[www.lamarzocco.com](http://www.lamarzocco.com)  
[info@lamarzocco.com](mailto:info@lamarzocco.com)

T: +39 055 849 191  
F: +39 055 849 1990

Original instructions verified by the manufacturer.



Scan QR Code to view the complete Software Programming Guide available on the techcenter website.

Printed on recycled paper.

## 1. General Warnings and Safety Specifications

### WARNING

This machine is for professional use only and should be installed in locations where its use and maintenance is restricted to trained personnel. Children are forbidden to operate or play with the machine.

### WARNING

The Coffee machine must be placed in a horizontal position on a counter higher than 80 cm from the ground.

### WARNING

This machine is not suitable for outdoor use. Jets of water should not be used to clean the machine, nor should it be placed where water jets are used.

### CAUTION

As already mentioned in the preceding notes, the manufacturer shall not be held responsible for damage to objects, animals and/or people whenever the machine has not been installed according to the instructions contained in this manual, and is not used to do what it was designed for (i.e. preparing coffee and hot drinks).

#### 1) Important safeguards

- The weighted sound pressure level of the machine is lower than 70dBA.
- Use, cleaning and maintenance of this coffee machine are realized by people (including children more than 8

years of age) with reduced physical, sensory or mental capabilities, or lack of experience and knowledge, as long as they have been given supervision or instructions concerning the use of the appliance by a person responsible for their safety and if they understand dangers.

- Children should be supervised to ensure that they do not play with the appliance.
- Keep the appliance and its cord out of the reach of children less than 8 years of age.

2) This operating manual is an integral and essential part of the product and

must be supplied to users. Users are asked to read the enclosed warnings and cautions carefully, as they provide valuable information concerning safety during installation, operation and maintenance. This manual must be kept in a safe place and be available for consultation to new and experienced users alike.

**3)** Ensure product's integrity by inspecting the packaging, making sure it presents no signs of damage which might have affected the enclosed machine.

**4)** Check the machine's integrity after having carefully removed the packaging.

**Note: In case of doubt, do not go**

**on any further and contact your dealer or retailer immediately. They will send out specialized personnel authorized to perform service on the espresso machine.**

**5)** Packaging (boxes, plastic bags, foam parts and whatever else) must not be left around within easy reach of children, due to the potential danger it represents, nor be discarded in the environment.

**6)** Check to see that data on the rating plate corresponds to those of the main electrical supply which the machine will be hooked up to.

**7)** The equipment must be installed to comply with the applicable federal, state or local electrical and plumbing

codes. The installation also must comply to the manufacturer's instructions, and must be performed by qualified and authorized personnel.

**8)** Incorrect installation may cause for injury/damages to people, animals or objects, for which the manufacturer shall not be held responsible.

**9)** Safe electrical operation of this device will be achieved only when the connection to the power outlet has been completed correctly and in observance of all local, national, and international electrical codes and safety regulations, and particularly by grounding the unit. Make sure grounding has



been done properly as it represents a fundamental safety requirement. Ensure qualified personnel check such connection.

10) Furthermore, you must ensure that the capacity of the available electrical system is suitable for the maximum power consumption indicated on the espresso machine.

11) We do not recommend using adapters, multiple plugs and/or extension cords. If you cannot avoid using them, make sure that they are exclusively of the kind which conforms to local, national, and international electrical codes and safety regulations, being careful not to exceed the power and current ratings

indicated on such adapters and extension cords.

12) This device must be used exclusively for the functions it has been designed and built for. Any other application is inappropriate and dangerous.

**The manufacturer shall not be held responsible for any damages caused by improper and/or irrational use.**

This machine should not be installed in kitchens.

13) Using any electrical device requires that certain fundamental rules be observed. In particular:

- do not touch the device with wet or humid hands and feet;
- do not use the device while having no shoes on your feet;

- do not use extension cords in bath or shower rooms;
- do not unplug the device from the power outlet by pulling on the power supply cable;
- do not expose the device to atmospheric agents (rain, sun, etc.);
- do not allow children or untrained people to use this device;
- do not clean the control panel with a wet cloth since it is not watertight.

14) Before carrying out any maintenance and/or cleaning operations, turn the main switch, which is located on the front left of the machine, to the “O” or “OFF” position, and disconnect the machine from the electrical network

by unplugging the cord or by switching off the relative circuit breaker. For any cleaning operation, follow exclusively the instructions contained in this manual.

**15)** In case the machine is operating in a faulty manner or breaks down, disconnect it from the electrical network (as described in the preceding point) and close the water supply valve. Do not attempt to repair it. Contact a qualified and authorized professional to perform any repair. Any repairs must be performed exclusively by the manufacturer or by an authorized centre using only original parts. Non compliance with the above could compromise the safe operation of the machine.

**16)** You should plan to make use of an omnipolar connector during installation, as required by local, national, and international electrical codes and regulations.

**17)** In order to avoid dangerous overheating problems, it is recommended that the power supply cable be fully unfurled.

**18)** Do not obstruct air intake and exhaust grilles and, in particular, do not cover the cup warmer tray with cloths or other items.

**19)** The machine's power supply cable must not be replaced by users. In case the power supply cable becomes damaged, shut off the machine and disconnect the

machine from the electrical network by switching off the relative circuit breaker and close off the water supply; to replace the power supply cord, contact qualified professionals exclusively.

**20)** These instructions are also available in an alternative format on a website <http://techcenter.lamarzocco.com>.

**21)** The machine should be placed on a flat counter and must be placed in settings with the following temperatures:  
Minimum room temperature: 5°C/41°F;  
Maximum room temperature: 32°C/89°F.

**22)** Check the package to make sure that the following

accessories are included:

- a number of 1-dose and 2-dose portafilters corresponding to the number of groups;
- replacement 1-dose and 2-dose filters (one of each);
- 1 tamper;
- 1 blind filter;
- cleaning detergent, for the groups;
- 3 stainless steel braided hoses for water connections;
- 1,5 mt of reinforced plastic tubing for drainage;
- 1 hose clamp.

**23)** If the machine has been temporarily housed in settings with a room temperature of less 0°C/32°F, the machine must be placed in a warmer environment in order to gradually defrost the hydraulic

system prior to use.

**24)** Water pressure supply must be between 0,2 and 0,6 MPa.

The maximum inlet water pressure shall be at least 1,0 MPa (Denmark, Norway, Sweden).

**25)** The machine is intended to be permanently connected to fixed wiring, and it is mandatory that a residual current device (RCD) with a rated residual operating current not exceeding 30mA is installed.

**26)** This machine is designed only for preparing coffee and hot drinks.

**27)** Any modification to the equipment is prohibited;

the manufacturer cannot be held liable for damage to property, animals, and/or persons if the equipment undergoes technical and aesthetic changes, changes in performance and characteristics, and in general is tampered with in one or more of its constituent components.

**28) Common Dimensions, Weights, and Features**

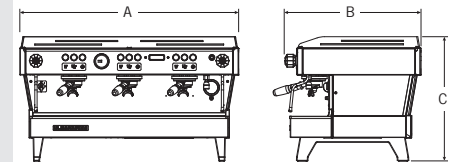

LINEA PB	2 groups	3 groups	4 groups
A [mm]	710	950	1190
B [mm]	588	588	588
C [mm]	533	533	533
WEIGHT [kg]	81	93	117

## 2. Definition of Available Models

**This operating manual refers exclusively to the following models, of our own manufacture:**

LINEA PB, Model AV, ABR and MP into 2, 3 and 4 groups

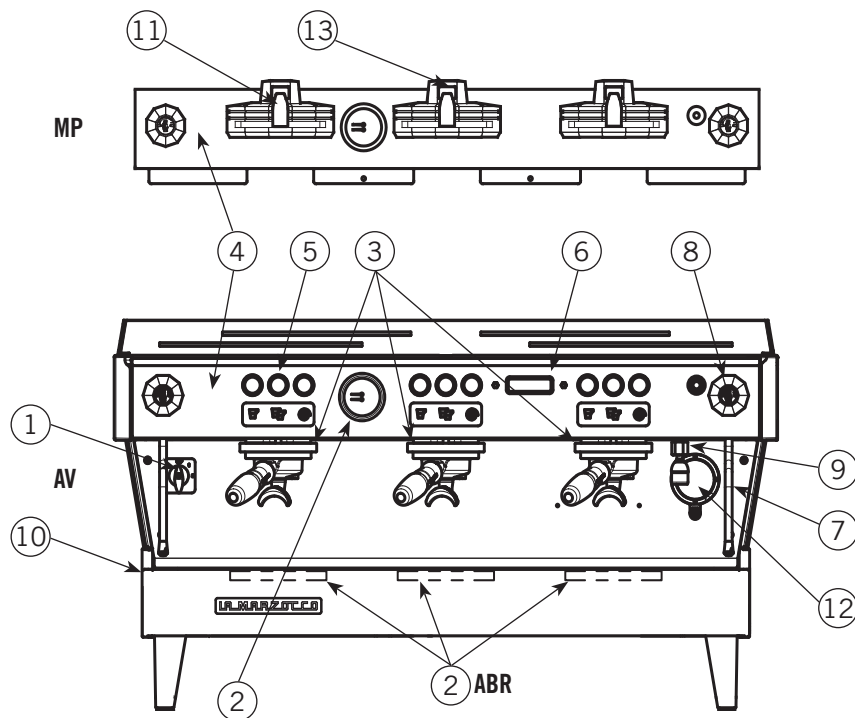

- 1** Main Switch
- 2** Pressure Gauge  
(Steam & Brew water)
- 3** Brew Groups
- 4** Control Panel
- 5** Group #1 Keypad
- 6** Digital Display
- 7** Steam Wand
- 8** Steam Knob
- 9** Hot Water dispense nozzle
- 10** Removable Drain Tray
- 11** Paddle Knob
- 12** Water Inspection Window
- 13** Timer
- 14** Precision Scale

For additional information on electronics, keypads, and software programming, please see the section entitled Software Programming your Espresso Machine.

**Fig. 1 - Model AV, ABR and MP with 2, 3, or 4 groups**

## 1) General description

The machine is built in 2, 3, and 4 coffee group versions and is essentially composed of the following parts:

- Steam Boiler (produces steam and hot water);
- Coffee (“saturated”) boiler;
- Brewing groups;
- Exterior Cover;
- Water pump.

## 2) Description of the various parts

### • Steam Boiler

The Steam Boiler consists of a cylindrical tank, of varying length according to the number of coffee groups, which is made of AISI 300 series stainless steel. Each unit is subjected to a hydraulic test, at a pressure of 6 bar, and has an operating pressure of 1.3-1.5 bar. The following is a list of effective volumes and power ratings according to the number of groups installed:

2 groups	7 liters
3 groups	11 liters
4 groups	15 liters

Covers are welded at either end of the cylindrical tank and on one of them there is a housing for the water heating element, which allows the steam boiler to reach operating pressure within approximately 25 minutes. Operating pressure is maintained

by an electronic temperature probe with a PID controller. The steam boiler has various fittings used for safety devices, for supplying hot water and steam, and for the heating element.

### • Coffee boiler

The Coffee Boiler consists of a cylindrical tank, of varying length according to the number of coffee groups, which is made of AISI 300 series stainless steel. Each unit is subjected to a hydraulic test, at a pressure of 18 bar, and has an operating pressure of 9 bar. The following table is a list of effective volumes and power ratings according to the number of groups installed:

2 groups	3.4 liters
3 groups	5 liters
4 groups	6.8 liters

Covers are welded at either end of the cylindrical tank and on one of them there is a housing for the water heating elements. The temperature of the coffee boiler is maintained by an electronic temperature controller (PID capable) with an accuracy of 0.2°C. The brewing groups are installed on the boiler.

### • Brewing groups

They consist of a precision casting made of stainless steel. The brewing group

accepts the portafilter used to hold the ground coffee; the espresso flows through the brewing group, through the portafilter basket, through the portafilter spout, and into the cup(s) after the brewing button has been pressed.

### • Exterior cover

The exterior consists of painted and stainless sheet steel panels. To provide good aesthetics, to optimize ergonomics for the operator and to reduce the chance of damage to a minimum.

### • Water pump

The rotary vane pump, is installed on the water supply tubing and is set up to operate anytime the coffee groups are activated, and through an autofill system whenever the water boiler needs to be replenished.

### • Sound pressure

The weighted sound pressure level of the machine is lower than 70dBA.

### • Water inspection window

The position of this device enables to verify only water presence inside the steam boiler. The water level in the window provides a reference about the water level in the steam boiler, but doesn't represent it in a directly proportional way, 1/3 of the windows is equal to approximately 1/2 of the boiler.

• Machine CE plate (AV version)

handmade in florence

● SERIE LINEA PB MODEL 4AV SIN PB0000 DATE 08/12 ●  
 V 4003N W 8700 A IImax 20 Hz 50/60  
 STEAM BOILER OP 0.15 MPa MAX PUMP P 0.9 MPa  
 COFFEE BOILER LITERS 6.8 STEAM BOILER LITERS 14.5  
 MAX WATER INLET P 0.8 MPa

[www.lamarzocco.com](http://www.lamarzocco.com)

ESPRESSO MACHINE Via La Torre 14H • 50038 Scarperia e San Piero (Firenze) MADE IN ITALY 

handmade in florence

● SERIE LINEA PB MODEL 4AV SIN PB0000 DATE 08/12 ●  
 V 220-240 AC W 8824 A 38.4 Hz 50/60  
 STEAM BOILER OP 0.15 MPa MAX PUMP P 0.9 MPa  
 COFFEE BOILER LITERS 6.8 STEAM BOILER LITERS 14.5  
 MAX WATER INLET P 0.8 MPa

[www.lamarzocco.com](http://www.lamarzocco.com)

ESPRESSO MACHINE Via La Torre 14H • 50038 Scarperia e San Piero (Firenze) MADE IN ITALY 

• Machine CE plate (MP version)

handmade in florence

● SERIE LINEA PB MODEL 4AV SIN PB0000 DATE 08/12 ●  
 V 4003N W 8700 A IImax 20 Hz 50/60  
 STEAM BOILER OP 0.15 MPa MAX PUMP P 0.9 MPa  
 COFFEE BOILER LITERS 6.8 STEAM BOILER LITERS 14.5  
 MAX WATER INLET P 0.8 MPa

[www.lamarzocco.com](http://www.lamarzocco.com)

ESPRESSO MACHINE Via La Torre 14H • 50038 Scarperia e San Piero (Firenze) MADE IN ITALY 

handmade in florence

● SERIE LINEA PB MODEL 4AV SIN PB0000 DATE 08/12 ●  
 V 220-240 AC W 8824 A 38.4 Hz 50/60  
 STEAM BOILER OP 0.15 MPa MAX PUMP P 0.9 MPa  
 COFFEE BOILER LITERS 6.8 STEAM BOILER LITERS 14.5  
 MAX WATER INLET P 0.8 MPa

[www.lamarzocco.com](http://www.lamarzocco.com)

ESPRESSO MACHINE Via La Torre 14H • 50038 Scarperia e San Piero (Firenze) MADE IN ITALY 

• Machine ETL plate (AV version)

handmade in florence

● MODEL LN/21 4AV SERIAL No. PB000000 ●  
 DATE 08/12 AMPS 33-39  
 VOLTS 208 - 240 Hz 60 SINGLE PHASE  
 MAX. OPERATING PRESSURE: STEAM 22 PSI WATER 161 PSI

[www.lamarzocco.com](http://www.lamarzocco.com)

ESPRESSO MACHINE MADE IN ITALY

• Machine ETL plate (MP version)

handmade in florence

● MODEL LN/21 4MP SERIAL No. PB0000 ●  
 DATE 08/12 AMPS 33-39  
 VOLTS 208 - 240 Hz 60 SINGLE PHASE  
 MAX. OPERATING PRESSURE: STEAM 22 PSI WATER 161 PSI

[www.lamarzocco.com](http://www.lamarzocco.com)

ESPRESSO MACHINE MADE IN ITALY

**WARNING**

The machine is intended to be permanently connected to fixed wiring, and it is mandatory that a residual current device (RCD) with a rated residual operating current not exceeding 30mA is installed.

**WARNING**

- ONLY FOR AUSTRALIA -  
The machine with rated input over 32A is intended to be permanently connected to mains power supply.

**WARNING**

In order to prevent cracks or leakage: do not store or install the Coffee machine in places where in boiler or hydraulicsystem to freeze.

**Note:**

- The drinking water mains valve and the circuit breakers for the electrical system need to be located in the most convenient position for the operator to access them easily and quickly.
- This machine complies with the standard 61000-3-11, the impedance at the supply interface must be  $Z_{max} = 0.17 \Omega$ .

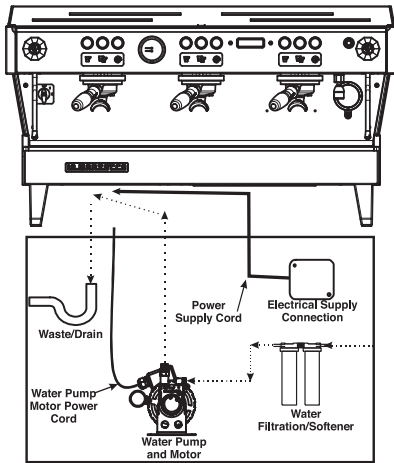

Fig. 2 - Installation Guide

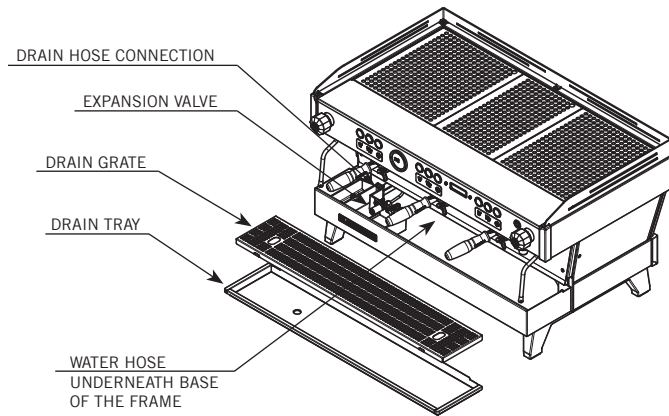

Fig. 3 - Installation Nomenclature

**WARNING**

The Coffee Boiler and Steam Boiler contain water at elevated temperature. Water temperature over 125°F / 52°C can cause severe burns instantly or death from scalding (Coffee Boiler 207°F/97°C - Steam Boiler 256°F / 124°C)

**WARNING**

Replace fuses with the same size, type and rating. e.g. F1 = 2A, 250V

**WARNING**

At each installation, the machine should be equipped with a new set of tubes for plumbing and related gaskets.

**WARNING**

This machine should not be installed in kitchens.

MODEL/SERIES	GROUP	V/Hz	RATED POWER (W)	RATED INPUT (A)	COFFEE BOILER WATTAGE	STEAM BOILER WATTAGE	TOTAL WATTAGE	POWER CORD SIZE (mm <sup>2</sup> )
GB5 X	2GR	AC220-240V/60Hz	4600	20-22	1400	3000	4400	SEE ELECTRICAL CONNECTIONS FOR DETAILS
		AC208-240/60Hz	4600	23	1400	3000	4400	
		AC380/50Hz	5040	12	1540	3300	4840	
	3GR	AC220-240V/60Hz	6100	25-29	1900	4000	5900	
		AC208-240/60Hz	6100	30,5	1900	4000	5900	
		AC380/50Hz	6690	15	2090	4400	6490	
	4GR	AC220-240V/60Hz	8000	33-39	2800	5000	7800	
		AC208-240/60Hz	8000	40	2800	5000	7800	
		AC380/50Hz	8780	20	3080	5500	8580	

**POWER CORD:**

3 X WIRES 1 X BLUE (NEUTRAL)  
220V  
1 X BROWN (PHASE)  
1 X YELLOW & GREEN (GROUND)



5 X WIRES 1 X BROWN (PHASE) 1 X BLUE (NEUTRAL)  
380V  
1 X GRAY (PHASE) 1 X YELLOW & GREEN (GROUND)  
4 X WIRES 220V  
1 X BLACK (PHASE)

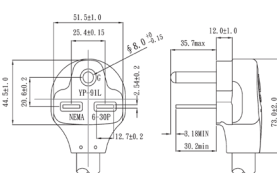
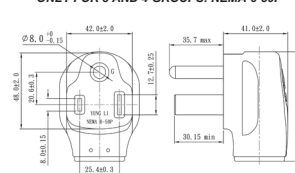

**WARNING**  
THE DETAILS ON THE LEFT DESCRIBE HOW TO CONNECT EACH WIRE TO THE PLUG. RESPECT ALSO THE LOCAL SAFETY REGULATIONS.

**(ONLY FOR ETL) POWER CORD:****ONLY FOR 2 GROUPS: NEMA 6-30P****ONLY FOR 3 AND 4 GROUPS: NEMA 6-50P****WARNING**

Water pressure supply must be between 0,2 and 0,6 MPa if sufficient pressure is not available we suggest that an additional water supply system is used.

**WARNING**

Before making any electrical connections make sure that the two strain relief connectors are firmly secured to the body of the machine in order to prevent inadvertent stress on the power cables.



**WARNING**  
 Hazardous voltage disconnect from power supply before servicing.

**WARNING**  
 The motor pump must be situated close to the machine in an accessible place for maintenance but not for accidental interference and where there is an optimal air circulation.

**WARNING**  
 The manufacturer declines any responsibility for any event leading to liability suits whenever grounding has not been completed according to current local, national, and international regulations and electrical codes, or other electrical parts have been connected improperly.

**WARNING**  
 This appliance is not intended for use by persons (including children) with reduced physical, sensory or mental capabilities, or with lack of experience and knowledge, unless they have been given supervision or instruction concerning the use of the appliance by a person responsible for their safety.

**WARNING**  
 - U.S.A. and CANADA only - Do not connect to a circuit operating at more than 150V to ground on each leg.

**WARNING**  
 This machine is not suitable for outdoor use. Jets of water should not be used to clean the machine, nor should it be placed where water jets are used.

Water specifications table

		Min.	Max.
T.D.S.	ppm	90	150
Total Hardness	ppm	70	100
Total Iron (Fe <sup>+2</sup> /Fe <sup>+3</sup> )	ppm	0	0,02
Free Chlorine (Cl <sub>2</sub> )	ppm	0	0,05
Total Chlorine (Cl <sub>2</sub> )	ppm	0	0,1
pH	value	6,5	8,5
Alkalinity	ppm	40	80
Chloride (Cl <sup>-</sup> )	ppm	not more	30

**N.B.:** Test water quality (the warranty is void if water parameters are not within the range specified in the section “installation”)

## 1) Installation on the counter

The image below shows the recommended method to drill the hole on the counter.

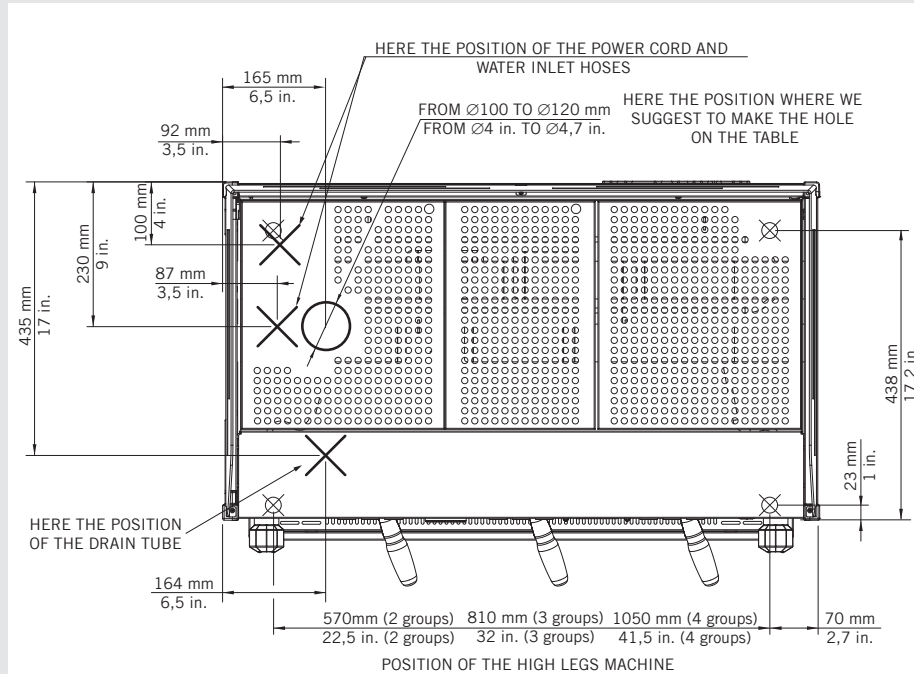

Fig. 4 - Hole on the Counter

## 2) Accessories

In order to proceed with installation, it is necessary that the following are available:

- Pipes carrying drinking water with a 3/8" G (BSP) end connection; (3/8" Compression for USA and Canada)
- Electrical Supply according to the specification of the espresso machine purchased:
- Single/Three phase 220VAC - 50/60 Hz electrical connection with ground, protected socket and approved interlock switch
- Single phase 200VAC - 50/60 Hz electrical connection with ground, protected socket and approved interlock switch
- Three-phase, 380VAC - 50 Hz electrical connection with neutral + ground, near the bench on which the machine is installed and terminating in a suitable protected fivepole socket equipped with an approved interlock switch
- Waste water drain system.

## 3) Water test kit

In order to enable you to check if your water supply is within the suggested ranges, La Marzocco machines will be equipped with two units of a quick water test kit (see image below) including 6 test-strips and instruction cards.

The parameters that you can measure are Total Hardness, Total Iron, Free Chlorine, Total

Chlorine, pH & Total Alkalinity, Chlorides.

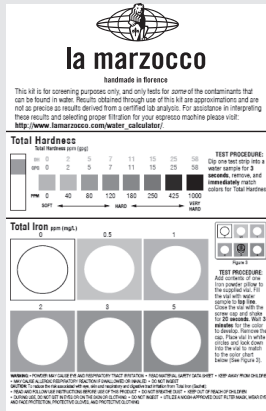

Ideally, you should perform a test on the water BEFORE the water treatment system and again AFTER the water system in order to verify if this is actually matching our suggested ranges.

Once the test has been performed, learn which treatment system is most appropriate for your particular water supply by filling out the online water calculator on our website: LA MARZOCCO WATER CALCULATOR ([http://www.lamarzocco.com/water\\_calculator/](http://www.lamarzocco.com/water_calculator/)).

#### 4) Water supply connection

In order to connect the machine up to the water mains proceed according to the indications given in the chapter about

Installation and in compliance with any local/national safety standards of the location in which the machine is being installed. The equipment is to be installed with adequate backflow protection to comply with applicable federal, state, and local codes.

To guarantee a correct and safe functioning of the machine and to maintain an adequate performance level and a high quality of the beverages being brewed it is important that the incoming water be of a hardness greater than 7°f (70ppm, 4°d) and less than 10°f (100ppm, 6°d), pH should be between 6.5 and 8.5 and the quantity of chlorides be less than 30mg/l . Respecting these values allows the machine to operate at maximum efficiency. If these parameters are not present, a specific filtration device should be installed, while always adhering to the local national standards in place regarding potable water.

Then connect the inlet of the water filter/softener (if present) to the drinking water supply using one of the supplied stainless steel braided hoses. Before connecting the filter to the water pump, flush the water supply line and the filtration system in order to eliminate any residual particles which could otherwise get stuck in taps or valves thus preventing them from working properly. Connect the water supply connection of the espresso machine to the water pump

outlet using one of the supplied stainless steel braided hoses. Then connect the water pump inlet to the water filter/softener outlet (if present).

**Note:** The water pump is a differential pressure volumetric pump and has been designed to be used exclusively with cold water. Make sure that water is always present while the pump is operating, otherwise air can be introduced into the brew boiler causing an undesirable condition and the pump can be damaged.

#### 5) Electrical connections

##### a) Power supply cord

- This is the main power supply cable that provides power to the entire espresso machine. There are different types of cable based upon the electrical requirements of the espresso machine purchased:
- 200/220VAC 1 Phase 3-core cable with 4/6/10mm<sup>2</sup> cross section or AWG 12/10/8 for 2,3 4 group versions, secured to espresso machine via a strain relief connector
- 220VAC 3 Phase 4-core cable with 4 mm<sup>2</sup> cross section for 2 , 3 and 4 group versions, secured to espresso machine via a strain relief connector
- 380 VAC 3 Phase 5-core cable with 2.5mm<sup>2</sup> cross section for 2, 3 and 4 group versions, secured to espresso machine via a strain relief connector.

### b) Water pump motor power cord

This is the power supply for the water pump motor. The internal electronics will switch the pump motor on when needed.

- 3-core cable with 1.5 mm<sup>2</sup> cross section or 3-core AWG 16 (for UL version) secured to espresso machine via a strain relief connector.

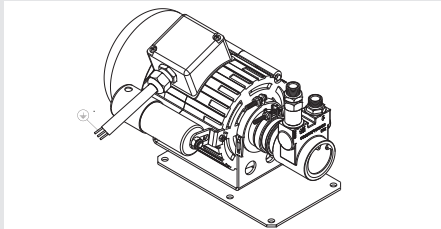

- Cable connection;

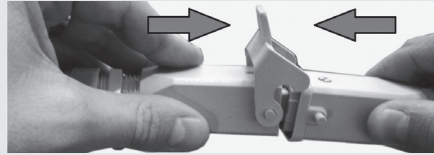

- Cable tightening;

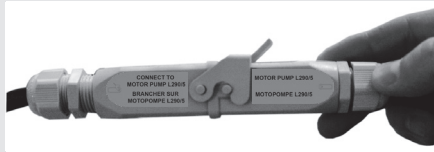

### c) Quick connection between the water pump and the espresso coffee machine

The electrical connection must be made through the use of the connectors, as shown in the following figures:

- View of the connectors;

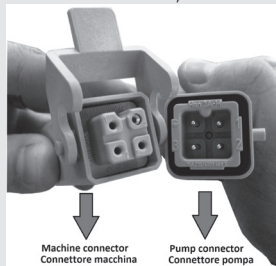

### 6) Waste water drain connection

The espresso machine drain is to be connected by means of the included reinforced plastic tubing. Connect one end of the reinforced plastic tubing to the drain hose connection on the left side of the espresso machine, secure with included hose clamp. Connect the other end to a suitable waste water collection system.

In case such a system is not available, drained liquids may be collected in a suitable bucket and any necessary drain pipe extensions shall be made using steel-lined PVC tubing and suitable hose clamps.

## 4. Machine Operation and Coffee Preparation

### CAUTION

Never remove the filter holder when water is being delivered. This operation can be extremely dangerous since the high pressure built-up inside the blind filter would spray out hot and slightly caustic water, which may cause severe burns. The Coffee Boiler contains water at elevated temperature. Water temperature over 125°F / 52°C can cause severe burns instantly or death from scalding.

### WARNING

The machine must not be dipped in, nor splashed with, water in order to clean it. For cleaning operations, please follow the instructions listed below very carefully.

### WARNING

This machine is designed only for preparing coffee and hot drinks.

#### IMPORTANT

To improve the flavor of the espresso, the temperature of the water in the coffee boiler and therefore of the groups may eventually be raised or lowered via the digital display (please consult the Software Programming Manual for detailed instructions).

#### 1) Starting the espresso machine

##### a) Filling the boilers with water

Once the installation procedures have been completed, it is necessary to fill the boiler tanks with water. Complete the following procedure to properly fill the boiler tanks:

##### • Coffee boiler

The water flows inside the coffee boiler directly, as soon as the water system and water filter/softener taps (if present) are opened. Since the inflow of water will compress the air in the boiler it will be necessary to remove or “bleed” the air from the coffee boiler. All air must be removed in order to completely “saturate” the coffee boiler/group assemblies. To remove the air from the boiler, “bleed the groups”, it will be necessary to remove the

group cover from the top of the machine. First remove the group tray from the top of the machine exposing the cup tray. Remove the screws securing the group cover and then remove it. Once removed the top of the groups will be exposed. Loosen the bleed screws one at a time (see fig.5 and 6) to allow air to escape until water flows from below the screw head.

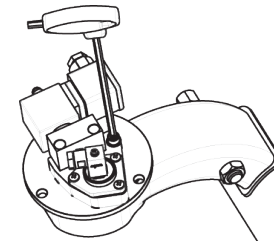

Fig. 5 - AV Version

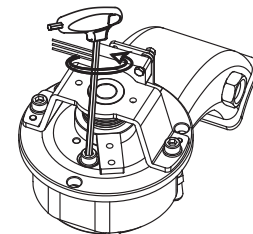

Fig. 6 - MP Version

Tighten the screw to stop the water from flowing. Over tightening can cause damage

to the sealing washer and the group cover. Repeat this procedure for all groups. Once all air is removed from the coffee boiler, reinstall the group cover by following the removal instructions in reverse.

#### • Steam boiler

Turn the main switch (item 1 in Fig. 1) to position “1” or ON, the automatic steam boiler level gauge will be switched on, activating the auto-fill solenoid valve and the motor pump. This will fill the steam boiler to a predetermined level and will shut off when full.

**Note:** It may happen that the air inside the steam boiler builds up pressure (which may be detected through the pressure gauge - item 2, fig. 1) when the water is allowed to flow in; this “false” pressure must be eliminated by opening the steam valves (item 8, Fig. 1).

#### b) Turning the espresso machine on

Once you have completed these procedures, check the display. Press enter to confirm that the preceding procedures are complete.

The installation is now complete and the espresso machine should be heating to the operating temperatures.

#### 2) Waiting for the espresso machine to heat to operating temperature

During this time, it may happen that the pointer of the coffee boiler pressure gauge

reaches as high as 14-15 bar. This may happen anytime that the heating element is in the on condition. In this case it is necessary to adjust the expansion valve (Fig. 3) in such a way that the pressure may never exceed 11-12 bar. In normal operating conditions, the coffee boiler pressure gauge can read anywhere from 0-12 bar.

When brewing, the pressure should be set to 9 bar.

When the steam boiler reaches operating temperature, the light on the hot water dispense button will light.

When the espresso machine is ready to operate all lights on the keypads will light.

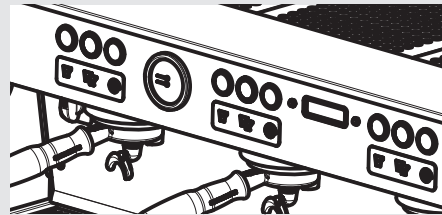

#### 3) Brewing after first installation

Once the first installation procedures are finished, before proceeding with brewing coffee, hot water and steam, please follow these steps:

- Engage the portafilters by inserting them into each group, brew water through each group for at least two minutes.
- Being careful to avoid burns, turn on each steam wand for at least one minute.
- Turn on the hot water valve for the time

necessary to allow the following quantities of water to be brewed:

At least 1 liter for a 1/2 group machine

At least 2 liters for a 3 group machine

At least 3 liters for a 4 group machine

#### 4) Installing the portafilters

Install the portafilter(s) by inserting them into the group and rotate the handle from left to right. When the portafilters are inserted properly, you can press any of brew buttons to start the flow of water through the portafilter. You should allow hot water to pass through the empty portafilter(s) for a few seconds each time, in order to pre-heat the portafilter.

**Note:** It is important to leave the portafilters installed in the espresso machine when not in use. The portafilter must remain heated for the brew process to function correctly.

#### 5) Water pump

Whenever you are brewing coffee, and you can adjust the pump pressure by turning the by-pass screw (below the plug located on the side to which the pump power supply is connected) clockwise to increase and counter-clockwise to reduce pressure. Adjust pressure only when at least one group is brewing coffee.

**Note:** When the heating element in the coffee boiler is energized, the water will expand increasing the start-up pressure.

Once the maximum pressure is reached, the expansion (safety) valve should start working by discharging a few drops of water, in order to prevent such pressure from exceeding 11-12 bar.

In case the pressure exceeds 12 bar, you must adjust the expansion valve by unscrewing the cap slightly. If this is not sufficient, remove the valve and clear away any calcium deposits. This remedy is valid also in case the valve remains open in the drain position (i.e. the pressure cannot increase to 8 bar approx.).

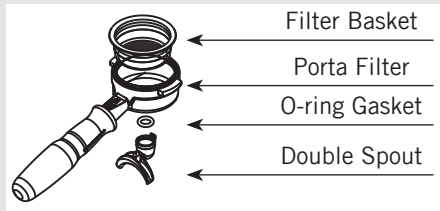

### 6) Brewing coffee

It is now possible to remove one of the portafilters to make an espresso beverage. Place some ground coffee in the filter itself: 1 dose (approximately 6-7 g) for the small filter, 2 doses (2 approximately 12-15 g) for the larger filter. Press down on the ground coffee with the supplied tamper and install the filter holder up again to the bottom of the group and then press a button (AV model) to begin the brewing process, or move the paddle lever (MP model).

Note: Some baristas believe it is important to press the brewing button prior to installing the portafilter to allow the water to flush any remaining coffee oils and particles from the group. Some also flush just after brewing coffee for the same reason. Please experiment to find the best possible procedure for you.

### 7) Controlling the brew process using volumetric programming (AV model only)

This espresso machine allows the volumetric programming of each of the first two buttons on each group (numbered left to right). Please consult the Software Programming Manual for further instructions.

### 8) General notes for coffee preparation

The portafilters must remain heated since they are at the lowest position of the group itself, and they are partially isolated due to the rubber gasket between them. This can be accomplished by leaving the portafilters installed in the machine when not in use. The portafilters may also be actively heated. This procedure may be carried out by brewing some hot water through the portafilter then turning off the water flow, before making coffee.

We recommend removing the spent coffee puck directly after brewing.

The size of the coffee granules is extremely important in preparing a good cup of coffee, other than the type of coffee mix used, quite obviously. The ideal grinding

can be determined by making various coffees using the amount of ground coffee that you would normally use for each cup (we recommend at least 6-7g). The best grinding is that which allows coffee to flow out from the filter holder spouts neither too slowly (drop by drop) nor too quickly (quick light brown flow). A general rule is that a double dose should dispense approximately 25cc or 2 fluid oz. of espresso in approximately 25 seconds.

## 5. Dispensing Steam and Hot Water

### 1) Steaming milk or other liquids

In order to allow for any condensed water in the wand to be released ALWAYS allow some steam to be discharged by turning on the valve before inserting the steam wand into the pitcher of liquid to be heated.

Dip one of the 2 steam wands (part 7, fig. 1) which are connected to the steam valve, into the liquid to be heated, turn the steam knob (part 8, fig. 1) gradually until steam comes out at the end of the wand. The steam will transfer heat to the liquid raising its temperature up to boiling point. Be careful not to allow liquid to overflow in order to avoid severe burns.

In order to prevent the heated liquid from being sucked back into the steam boiler it is recommended before using the wand that you purge the steam valve and steam wand by opening the valve for a few seconds to allow steam to escape to the atmosphere from the end of the steam wand. Failure to do so can cause the heated liquid to transfer from the heated liquid container to the steam boiler (via vacuum created from cooling parts). This condition is undesirable and can cause contamination in the steam boiler. After use remember to purge the wand by opening the steam valve for a few seconds,

and then clean the outside of the wand itself with an appropriate cloth.

In order to prepare milk for making cappuccino with the right amount of foam, go through the following steps:

- After purging the steam wand place the container half-full of milk underneath, carefully open the steam valve and raise the container so as to bring the wand end to a point just below the surface of the milk; at this point, move the container up and down just enough to dip the nozzle end in and out of the milk until you get the right amount of foam, bring the temperature of the milk almost up to 149/158°F or 65/70°C. You can then pour this milk into a cup containing warm espresso and you will end up with a fresh cup of cappuccino.

### 2) Preparing hot water and other hot drinks

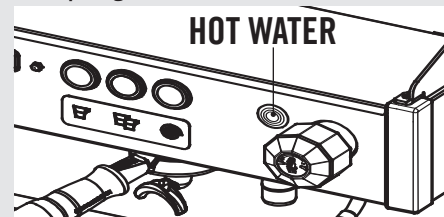

You may dispense hot water by using the fixed nozzle (item 9 fig 1). To dispense hot water, press the hot water button on the right most group.

This button commands the hot water delivery.

The volume of water delivered may be adjusted via the display (see the Software Programming Manual for further instructions). The temperature of the water dispensed may be adjusted by adjusting the mixing valve under the right side cover of the espresso machine. (only on the models of espresso machine equipped with this accessory)

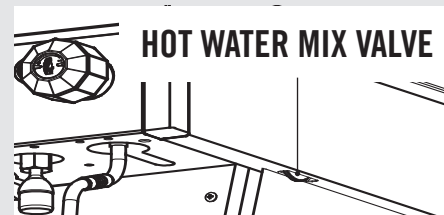



## 6. Maintenance and Periodic Cleaning Operations

### WARNING

If the above-mentioned instructions are not adhered to the manufacturer cannot be held responsible for damage to persons or things.

### WARNING

In order to prevent cracks or leakage: do not store or install the coffee machine in places where temperature may cause water in boiler or hydraulic system to freeze.

### WARNING

The machine is intended to be permanently connected to fixed wiring, and it is advisable that a residual current device (RCD) with a rated residual operating current not exceeding 30mA is installed.

### WARNING

The machine must be installed so that qualified technical personnel can easily access it for eventual maintenance.

### WARNING

The machine must not be dipped in, nor splashed with, water in order to clean it. For cleaning operations, please follow the instructions listed below very carefully.

### WARNING

Do not remove the filter holder while relative group is brewing hot liquids.  
The Coffee Boiler contains water at elevated temperature. Water temperature over 125°F / 52°C can cause severe burns instantly or death from scalding.

### WARNING

This machine is for professional use only and should be installed in locations where its use and maintenance is restricted to trained personnel.

### WARNING

Jets of water should not be used to clean the machine, nor should it be placed where water jets are used.

#### 1) Cleaning groups and drain wells

- Put a tablespoon of detergent powder for coffee machines into the blind filter, supplied with the machine, and tighten it onto the group you want to clean by using a normal filter holder.

- For AV models: activate the automating rinsing (backflushing) routine (see the Software Programming Manual for more detailed instructions). For MP models: brew water for 3 sec and repeat ten times for each group.

- Rinse the group using a normal filter, by running hot water through it several times

#### 2) Cleaning filters

- Put 2 or 3 teaspoons of detergent powder for coffee machines in about 1/2 a litre of water inside a heat-resistant container and boil.

- Dip filters in the boiled solution and leave them fully submerged for about 30 minutes.
- Rinse thoroughly with clean water and run hot water through one group several times with the filters in place.
- Make one cup of coffee and discard in order to remove any unpleasant flavor.

### 3) Cleaning filter holders (portafilters)

Using the proper cleaning tool (brush) wash the filter holders under hot water, a neutral detergent may also be used. For extraordinary cleaning see the Portafilter Manual.

### 4) Cleaning the drain collector

Remove the drain tray grill at least twice a week and clean, pull out the water drain collector and clean it thoroughly. Inspect and clean also the drain box and remove any leftover grounds.

### 5) Cleaning the body

Wipe the stainless steel surfaces with a soft, non abrasive cloth in the direction of the glazing marks, if any. Do not use any alcohol or solvents whatsoever on painted or imprinted parts in order not to damage them.

### 6) Cleaning the hot water and steam nozzles

Steam nozzles must be cleaned immediately after use with a damp cloth and by producing a short burst of steam so as to prevent the formation of deposits inside the nozzles themselves, which may alter the flavor of other drinks to be heated. Hot water nozzles must be cleaned periodically with a damp cloth.

### 7) Cleaning the diffuser screen

- Due to filter holder discharge operations (subsequent to coffee brewing), a certain amount of coffee grounds may slowly build-up on and obstruct, even partially, the diffuser screen. To clean it, you must first remove it by unscrewing the diffuser screw.
- Put 2 or 3 teaspoons of cleaning detergent for coffee machines in about 1/2 a litre of water inside a heat-resistant container and boil.

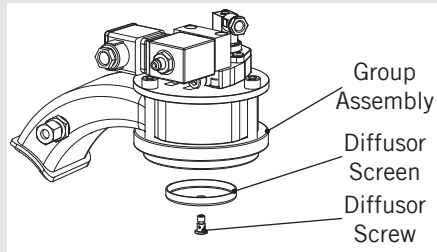

- Place the diffuser screen(s) and diffuser screw(s) in the solution and leave them fully submerged for about 30 minutes. Rinse thoroughly with clean water. Install and run hot water through each group several times with the screen installed.

### 8) Water Filter/Softener

Please see the documentation accompanying the water filter/softener for proper operating and cleaning instructions.

- **Steam boiler draining:** to activate this function you need to access the programming menu (see p. 97). Yearly, we recommend to fully drain the steam boiler by means of the

specific drain cock located on the side of the boiler or under the boiler.

### 10) Depressurize the steam boiler

Press and hold the encoder knob to set the espresso machine to "OFF", then push down the steam lever in order to depressurize the steam boiler.

### IMPORTANT

If the machine has not been used for more than 8 hours or, in any case, after long periods of being idle, in order to use the machine to its full potential it is necessary to perform some cleaning cycles before brewing beverages as follows:

- Groups: with the portafilters engaged in the groups brew water through each for at least two minutes
- Being careful to avoid burns, turn on each steam wand for at least one minute.
- Turn on the hot water valve for the time necessary to allow the following quantities of water to be brewed:
  - At least 1 liter for a 1/2 group machine
  - At least 2 liters for a 3 group machine
  - At least 3 liters for a 4 group machine

If the machine is not going to be used for long periods of time, it is advisable to follow these safety indications:

- Disconnect the machine from the water mains or interrupt the water connection via a mains tap.
- Disconnect the machine from the electrical mains.

## 7. De-commissioning and Demolition

### 1) De-commissioning and demolition

Start by setting the main switch to the “0” or OFF position.

#### Disconnecting from the power outlet

Disconnect the espresso machine from the electrical network by switching off the associated circuit breaker or circuit protection device. Remove the power supply cord from the power connection. Remove the Pump Motor Power Cord from the water pump motor.

#### Disconnecting from the water system

Shut off the water supply by closing the specific tap located upstream of the water filter/softener inlet. Disconnect the water pipe at the water filter/softener inlet.

Remove the hose connecting the espresso machine to the water pump. Remove the reinforced plastic tubing on the drain connection.

At this point, the machine may be removed from the bar, being very careful not to drop it or squash your fingers.

The machine is made out of various materials and therefore, if you do not intend to put it back in service, it must be taken to a special disposal company which will select the materials which can be recycled and discard the others.

Current regulations make it illegal to discard such machine by leaving it on public grounds or on any private property.

#### Recycling notice: Warning for the protection of the environment.

Used Electrical and electronic waste contains hazardous but also valuable and scarce materials which should be recovered and recycled properly. We kindly ask that you contribute to the protection of the environment and natural resources by delivering used equipment to the relevant recycling locations if such locations are available in your country.



## 8. Mandatory Maintenance and Check-up Operations

These operations are in addition to the Maintenance and Periodic Cleaning Operations as specified in Chapter 6.

The following maintenance and check-up operations should be carried out by a qualified technician. The time required for the periodic maintenance is determined by the quantity of daily work and/or coffee consumption.

**N.B. These periodic maintenance operations are not covered by warranty.**

### EVERY THREE/FOUR MONTHS

- Replace group gaskets
  - Replace diffuser screens
  - Check filter baskets and springs condition
  - Clean auto-fill probe
  - Check vacuum breakers for proper operation
  - Check fittings and valves for leaks
  - Inspect drain box and hose for leaks or clogs
  - Check flow rate for each group
  - Check brewing pressure
  - Check all buttons for proper operation
  - Check expansion valve operation
  - Check steam valves for proper operation
  - Check/note water hardnessm (Water quality must be within the range of parameters specified in the chapter on Installation, otherwise warranty is voided)
  - Test flowmeter's ohm value (ohm value is acceptable if greater than 1.8 K ohm, and less than 2.2 K ohm)
- If ABR Model:**
- Run "scale test"
- If AV Model:**
- Check doses consistency

### EVERY SIX (in addition to the above)

- Replace filter baskets
- Fit steam valve rebuild kit
- If ABR Model:**
  - Calibrate scales
- Check weight of precision portafilters

### EVERY YEAR (in addition to the above)

- Inspect solenoid valves
- Replace vacuum breakers
- Inspect expansion valve
- Inspect electrical wiring condition
- Inspect boilers safety switches
- Replace over-pressure valve (safety valve)
- Accurate control of the tightness at 2,4Nm of each cable on the terminal block.
- If AV Model:**
  - Inspect flowmeter impellers
- If MP Model:**
  - Rebuild mechanical valves
  - Bleed all groups

### EVERY 3 YEARS (in addition to the above)

- Check the condition of the inside of boilers and if necessary rinse out with a proper cleaning product allowed for food and beverage appliances.

## 9. Precision Scale

**WARNING**  
Handle with care maximum load  
1Kg do not lift.

### 1) Use precautions

The weighing system in static conditions (\*) has a rated accuracy of +/- 0.5g.

For correct operation, make sure that:

- Maintenance is performed properly, by an authorized person and in the manner prescribed in this manual;
- Please use the machine according to the instructions specified in this manual;
- Please make sure the machine is installed on a level and firm counter;
- Please make sure the power supply is stable and without electrical noises.

The weighing stage is inherently delicate, in fact it is affected by:

- Vibration of the bench caused for example by other devices;
- Machine vibrations caused, for example, by the use of the adjacent group.

(\*) Static weighing means weighing an object whose weight is fixed during the entire weighing.

The machine is not a weighing device

certified for legal weighing.

- The weighing system is a precision device that requires a lot of caution in terms of use, cleaning and maintenance.

- Should the main grid or tray be removed, ensure not to hit the load cells during the disassembly and reassembly operations.

- To proceed with the weighing of the filter holder either empty or filled with coffee powder, place it as shown below:

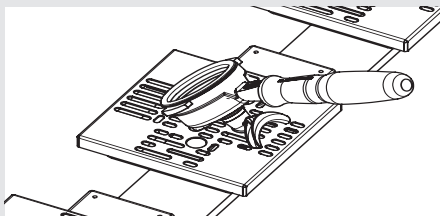

- Use only original La Marzocco filters and filter holders, identified by the following symbol:



- Use only filter holders with double spout;

- Do not place on the scale objects weighing more than 1kg;

- Never load more than 1 kg, to prevent any damage to the scales;

- Use the high precision scale with care, avoid shocks, falling objects and sudden load peaks;

- Any object to be weighed must be placed correctly on the scales grid.

### 2) Cleaning

- The cleaning of the “individual grids” must be performed with care, without overloading the cells;

- For proper weighing of the filter holder, make sure the grid is clean and dry;

- To avoid contact with dirt before placing the filter holder, clean and dry the grid;

- Please be careful during the cleaning procedures to avoid the water dripping on the scale and its electrical components.

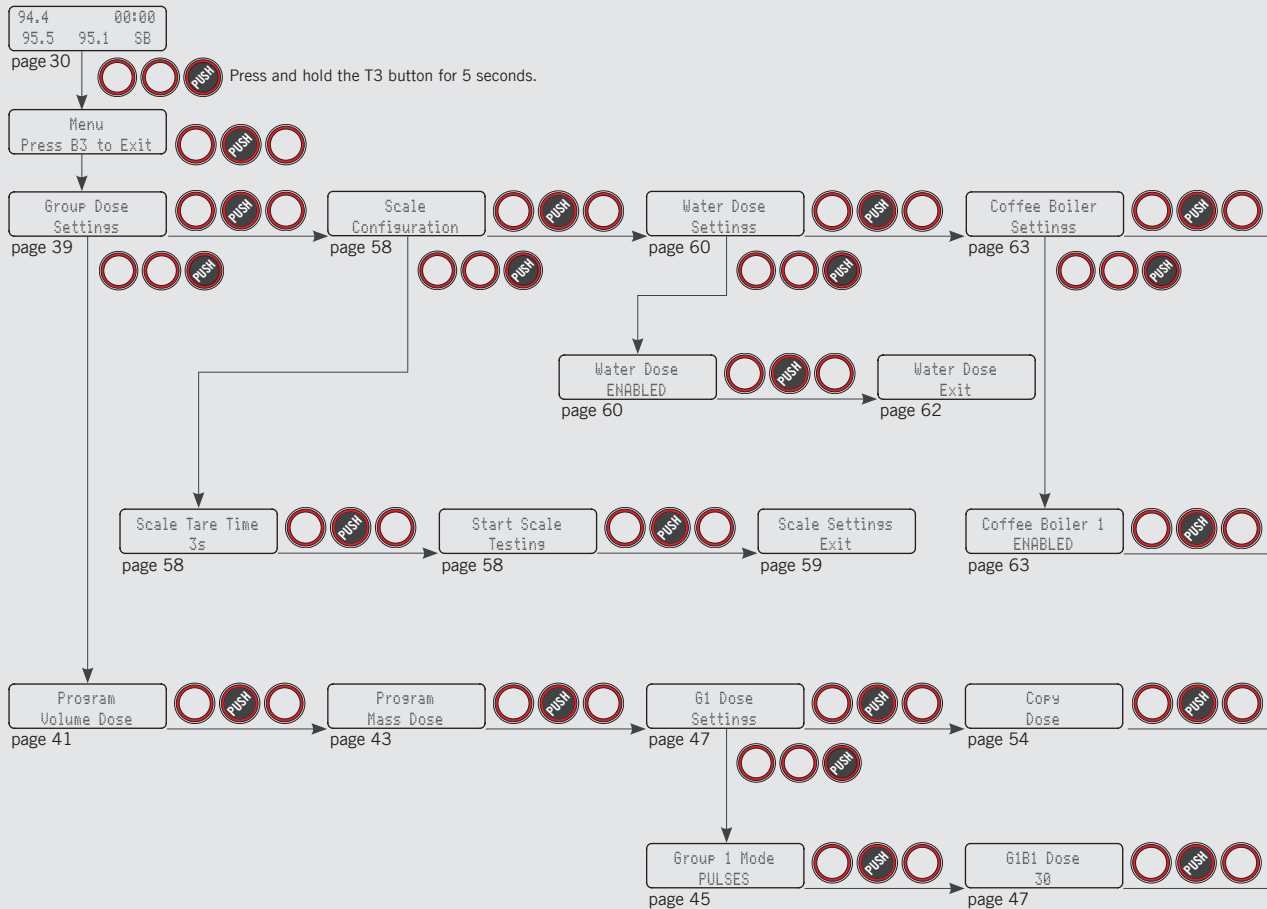

# “Barista” Programming

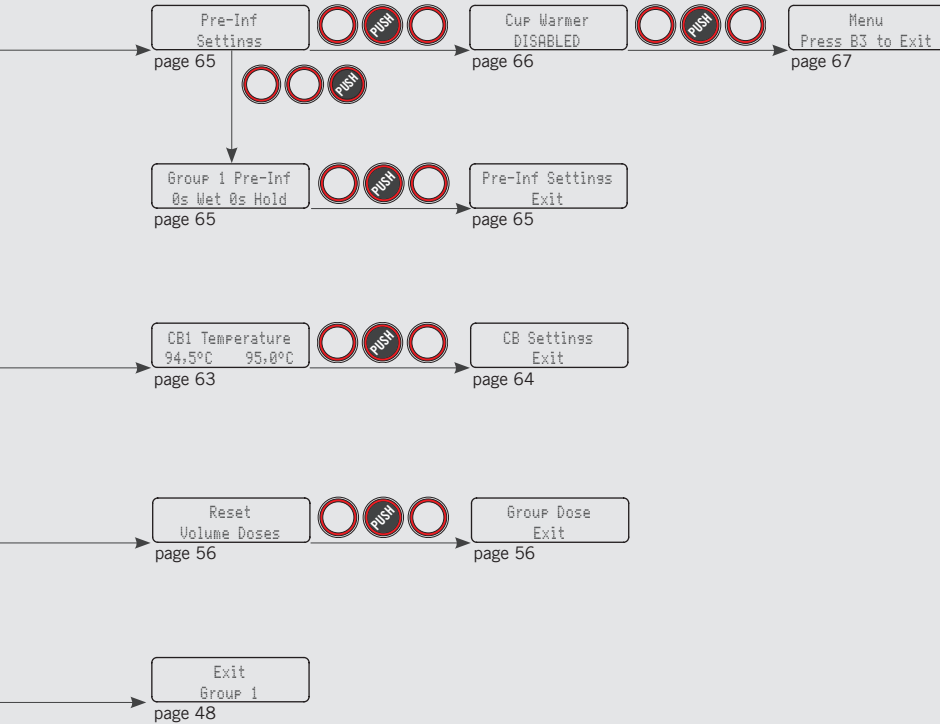

# “Technical” Programming

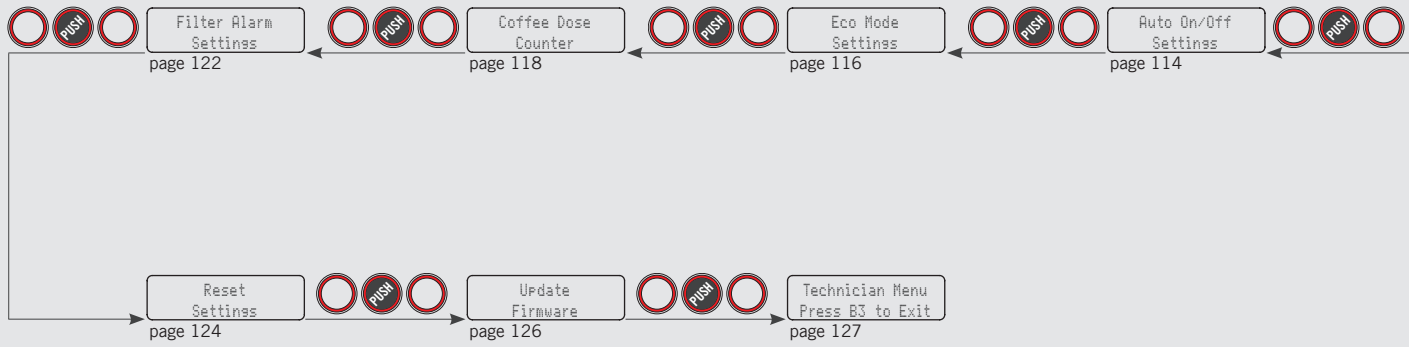
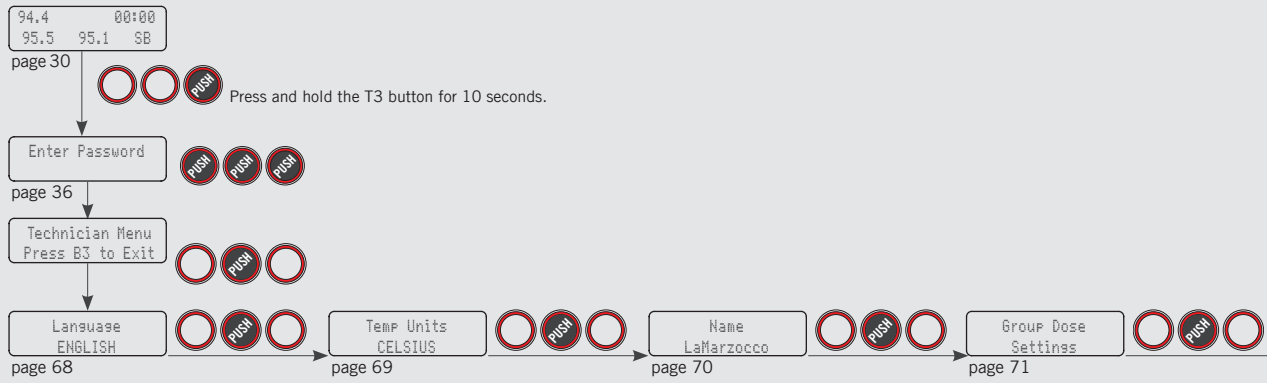



# “Technical” Programming

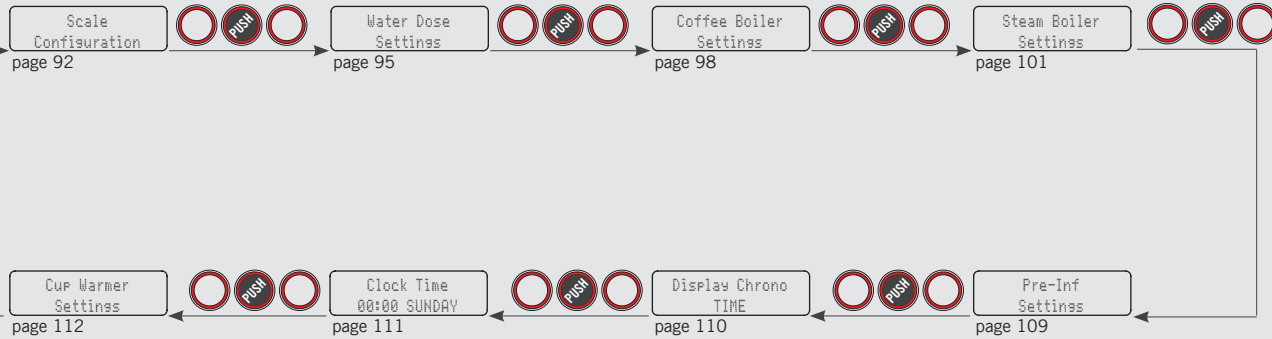

## Programming Introduction

---

### Description

- This espresso machine has a CPU and many configurable settings.
- Additionally, there are many feedback controls employed in this espresso machine to troubleshoot problems should they occur.
- The following is a brief introduction to the controls and display and how they interact with the operator.

## Digital Display

---

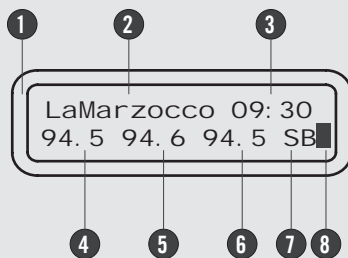

- |   |                                     |   |                                                                                  |
|---|-------------------------------------|---|----------------------------------------------------------------------------------|
| 1 | Digital display                     | 5 | 2nd group coffee boiler temperature                                              |
| 2 | Name                                | 6 | 3rd group coffee boiler temperature                                              |
| 3 | Daily timetable                     | 7 | Steam Boiler                                                                     |
| 4 | 1st group coffee boiler temperature | 8 | Heating indicator (on during heating, off when the temperature has been reached) |

The digital display is a backlit display capable of displaying 2 lines of 16 characters. The display enables the operator to interact with the espresso machine to visibly change parameter values. The display also provides valuable information to the operator.

There are several warnings that can be displayed to alert the operator of an unusual condition or a fault. Additionally, simple messages are displayed alerting the operator that an action has been started or that a process needs to begin.



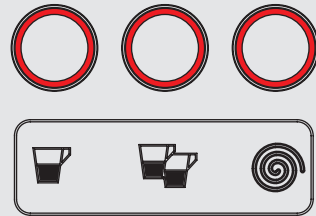

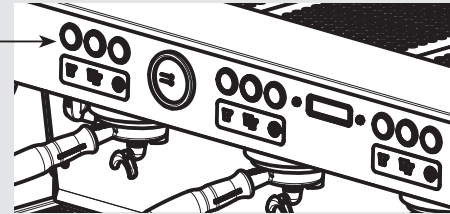

## Programming Keypad (AV Version)



Group 1









The keypad has two functions. The first is for control of the espresso. The second is for programming individual software parameters. The programming of the individual parameters is possible only using the buttons in the group 1 (group starting from the left).

Button	Description
	<p>This button is used to control the brewing of the single espresso. It is also used in the programming of the individual parameters such as the “back” button in the menu.</p> <p>For simplicity's sake in this manual it will be represented by this symbol  with the name <b>T1</b>.</p>
	<p>This button is used to control the brewing of the double espresso. It is also used in the programming of the individual parameters such as the “forward” button in the menu.</p> <p>For simplicity's sake in this manual it will be represented by this symbol  with the name <b>T2</b>.</p>
	<p>This button is used for a continuous control of the brewing of the espresso. It is also used in the programming of the individual parameters such as the “enter” button in the menu.</p> <p>For simplicity's sake in this manual it will be represented by this symbol  with the name <b>T3</b>.</p>

## Programming Keypad (MP Version)



The programming of individual parameters is possible only using these buttons.

Button	Description
	<p>This button is used to control the brewing of the single espresso. It is also used in the programming of the individual parameters such as the “back” button in the menu.</p> <p>For simplicity's sake in this manual it will be represented by this symbol  with the name <b>T1</b>.</p>
	<p>This button is used to control the brewing of the double espresso. It is also used in the programming of the individual parameters such as the “forward” button in the menu.</p> <p>For simplicity's sake in this manual it will be represented by this symbol  with the name <b>T2</b>.</p>
	<p>This button is used for a continuous control of the brewing of the espresso. It is also used in the programming of the individual parameters such as the “enter” button in the menu.</p> <p>For simplicity's sake in this manual it will be represented by this symbol  with the name <b>T3</b>.</p>

## Turning the Espresso Machine On

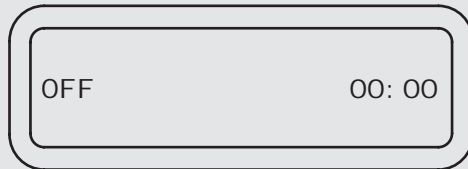

### Description

The following is the procedure to be followed for the first use of the espresso machine.

- Please follow the procedures carefully to avoid any damage to the espresso machine.
- Proceed checking for water connection to the espresso machine.

- Proceed making sure you have filled the boilers.
- For the MP version, ongoing warming is indicated by the timer located on the groups using digit rotation.

Display	Operating Procedure
	<b>1</b> Turn the Main Switch to the 1 position.
SB FILLED?	<b>2</b> To continue with the start up process, press the T3 button   after filling the steam boiler.
GROUPS BLEED?	<b>3</b> To continue with the start up process, press the T3 button   after the saturation of the coffee boiler.
LaMarzocco 00:00 CB 93.8°C SB	<b>4</b> The rectangles next to CB and SB indicate the warming up of the water contained in the boilers. When the set temperature is reached, these rectangles turn off and all the lights of the buttons turn on. Now the machine is ready for use. During the normal operation of the machine, the flashing of the rectangles indicates the intermittent heating necessary for maintaining the temperature.
	<p><b>NOTE:</b> Ensure all air is removed from the group prior to starting the espresso machine. This only needs to be completed once during the initial setup or when water is drained from the coffee boiler. Instructions for bleeding the groups of air can be found in the Installation Guide.</p>

**⚠ WARNING ⚠**

**HAZARDOUS VOLTAGE DISCONNECT FROM POWER  
SUPPLY BEFORE SERVICING**

## Start Up Procedures

### Turning the Espresso Machine On

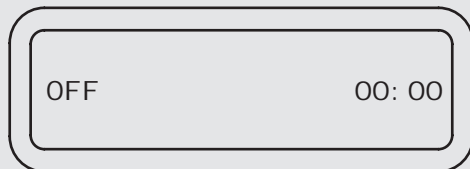

### Description

The following is the procedure for turning on the power to the espresso machine.

- Please follow the procedures carefully to avoid any damage to the espresso machine.
- Proceed checking for water connection to the espresso machine.

- Proceed making sure you have filled the boilers.
- For the MP version, ongoing warming is indicated by the timer located on the groups using digit rotation.

Display	Operating Procedure
	<p><b>1</b> Turn the Main Switch to the 1 position.</p>
	<p><b>2</b> The message shown to the left will be displayed when the espresso machine is switched on.</p>
	<p><b>3</b> To complete the start up process, press any button. The screen shown to the left will be displayed. The rectangles next to CB and SB indicate the warming up of the water contained in the boilers. When the set temperature is reached, these rectangles turn off and all the lights of the buttons turn on. Now the machine is ready for use. During the normal operation of the machine, the flashing of the rectangles indicates the intermittent heating necessary for maintaining the temperature.</p> <p><b>NOTE:</b> Ensure all air is removed from the group prior to starting the espresso machine. This only needs to be completed once during the initial setup or when water is drained from the coffee boiler. Instructions for bleeding the groups of air can be found in the Installation Guide.</p>

**⚠ WARNING ⚠**

**HAZARDOUS VOLTAGE DISCONNECT FROM POWER  
SUPPLY BEFORE SERVICING**

### Turning the Espresso Machine Off

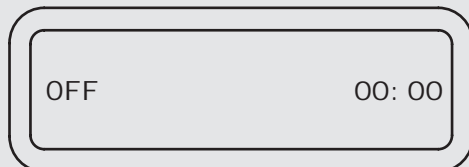





#### Description

The following is the procedure for turning off power to the espresso machine.

- Please follow the procedures carefully to avoid any damage to the espresso machine.

- This machine has two off settings. One setting turns off all of the components in the espresso machine and the other turns off power to the complete espresso machine.

Display	Operating Procedure
	<p><b>1</b> The following is the procedure for safely turning off the espresso machine.</p>
	<p><b>2</b> Press and hold the buttons T2   and T3   at the same time.</p>
<p>The display changes to the following:</p>	
	<p><b>3</b> This is the OFF setting used in the normal operating conditions.</p>
	<p><b>4</b> During servicing or other conditions that warrant it, the main switch should be turned to the 0 position.</p>
	<p>The espresso machine is off and display should be blank. It is important to follow this procedure when turning off the machine. Failure to do so can damage the electronics.</p>

**⚠ WARNING ⚠**  
**HAZARDOUS VOLTAGE DISCONNECT FROM POWER  
 SUPPLY BEFORE SERVICING**

## Accessing Programming Mode

### Programming Mode

LaMarzocco 00:00  
CB 93.8°C SB

















### Description

- To change the values of any parameter the operator must first enter into the programming mode.
- There are two levels within the programming mode that allow the programming of specific parameters.
- The two programming levels are as follows:
- **Barista Programming** - The parameters contained within this level are ones the operator can change to affect the

quality of the espresso.

No password is required for access.

- **Technical Programming** - The parameters contained within this level are ones the operator can change to affect the performance of the espresso machine. These parameters are set in the factory and their adjustment requires the intervention of a service technician La Marzocco recommends that no changes are made at this level. The Technician Password is required for access.

Display	Operating Procedure
<p>LaMarzocco 00:00 CB 93.8°C SB</p> <p>Program Dose</p> <p>Press Enter To Exit</p>	<p><b>“Barista” Programming Level</b></p> <ol style="list-style-type: none"> <li>1 While the espresso machine is on, press and hold the button T3  . After approximately 5 seconds the following display appears.</li> <li>2 This is the “Barista” programming level. To program the brewing amount for each button, to set the coffee boilers, the pre-infusion, and to enable/disable the resistance of the cup warmer if present.</li> <li>3 To exit the programming mode, scroll to the exit menu, using the buttons T1   or T2  . Press the T3   button to confirm the exit, or press at the same time the buttons T2 and T3.</li> </ol>
<p>LaMarzocco 00:00 CB 93.8°C SB</p> <p>Enter Password</p>	<p><b>“Technical” Programming Level</b></p> <ol style="list-style-type: none"> <li>1 While the espresso machine is on, press and hold the button T3  . After approximately 10 seconds the following display appears.</li> <li>2 This is the “Technical” programming level. Enter the password and press the buttons T1   and T2   to move between the available parameters, press the T3 button   to confirm.</li> </ol> <p>Note: You must scroll to the exit menu to exit the programming mode, or press at the same time the buttons T2 and T3.</p>





## Cleaning Cycles

GR1  
Backfl ushi ng

### Description

- This parameter allows the operator to carry out the washing of the coffee groups, in an automatic way, by running multiple cleaning cycles.
- This espresso machine has a group backflush function (rinsing jets) integrated in the electronics.
- The backflush procedure is provided to give the operator more flexibility and freedom with regard to this operation.
- For the MP version, washing is carried out manually by enabling the delivery through the paddle lever and then closing (part no. 11 in Fig. 1).

Display	Operating Procedure
<div data-bbox="158 585 313 627" style="border: 1px solid black; padding: 2px; width: fit-content;">                     GR1 Backfl ushi ng                 </div>	<ol style="list-style-type: none"> <li data-bbox="335 587 1526 687">                     1 When the espresso machine is on, to enable the washing procedure press and hold at the same time the buttons T1  and T3 . This activates the washing procedure of each group.                 </li> <li data-bbox="335 723 1526 811">                     2 When activated, the water pump comes into operation, and the electric valve of the specific group being washed will turn on and off the cycle. There are about 10 preset cycles with an interval of 4 seconds. To manually stop the rinsing, press any key.                 </li> </ol> <p data-bbox="381 871 1526 925"><b>NOTE:</b> In order to properly rinse the groups, put a small amount of detergent in a blind portafilter basket and insert it in the group to be rinsed before activating the rinsing process.</p> <div data-bbox="393 964 1483 1141" style="border: 2px solid black; padding: 10px; text-align: center;"> <p data-bbox="409 972 447 1000"><b>⚠</b></p> <p data-bbox="872 968 1004 1004"><b>WARNING</b></p> <p data-bbox="612 1020 1268 1064">MOST DETERGENTS CAUSE FOAMING DURING THE CLEANING PROCESS. THIS FOAM COLLECTS AT THE DRAIN BOX AND CAN PROHIBIT WASTE WATER FROM DRAINING PROPERLY.</p> <p data-bbox="822 1066 1058 1084">RINSE ONLY ONE GROUP AT A TIME.</p> <p data-bbox="637 1087 1240 1105">RINSING MULTIPLE GROUPS SIMULTANEOUSLY COULD CAUSE THE DRAIN BOX TO OVERFLOW.</p> <p data-bbox="1433 972 1471 1000"><b>⚠</b></p> </div>

## Brewratio Programming (only on ABR espresso machine models)

### Brewratio

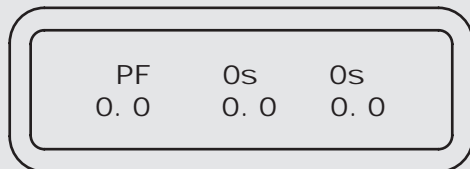



### Description

The procedure for weighing the filter holder either empty or filled with coffee powder is shown below.

- This parameter records the values for the brew according to the brew ratio technology.
- These values can be changed even manually by entering the software settings.

- To brew in brew ratio mode, set this mode by entering the software settings.
- Brew ratio: this mode is the ratio between the coffee powder and the weight of the drink









Display	Operating Procedure
	<p><b>1</b> When the espresso machine is on, press and hold the button T2 . After about 5 seconds the following screen is displayed.</p>
	<p><b>2</b> When the value is no longer flashing, place the empty filter holder on the appropriate seat of the grid as described in chapter 9. The value is automatically recorded. (*)</p>
	<p><b>3</b> Press and hold the button T1 . After about 5 seconds the following screen is displayed.</p>
	<p><b>4</b> When the value is no longer flashing, place the filter holder filled with coffee powder on the appropriate seat of the grid as described in chapter 9. The value is automatically recorded.</p> <p>This procedure can be repeated for all the brewing groups.</p> <p>(*) This procedure must be performed at the first installation, though it is possible to repeat it anytime (for example if you get a new portafilter set).</p>

## Program Dose

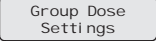
Group Dose  
Settings

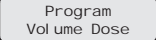
### Description

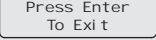
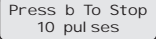
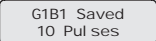
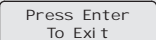
- This parameter allows the operator to program the amount of coffee (brewing amount) for each button on the keyboard.
- The brewing amount can be set in terms of time (sec. ) or pulses. This number refers to the number of pulses that the flowmeter sends to the CPU.
- Once programmed, the button remains lighted.

Display	Operating Procedure
	<b>1</b> When the espresso machine is turned on, press and hold the T3 button  to access the “Barista” programming. After about 5 seconds the following screen is displayed.
	<b>2</b> Press the T3 button  to enter the doses programming procedure.
	<b>3</b> Press the T3 button  to start the doses programming procedure.
	<b>4</b> To program the coffee brewing time, press the dose button to start and then press it again to stop, once the desired dose is achieved. Successful programming is indicated by the lighting of the button. This operation must be repeated for each button whose dose you want to set. The buttons can be programmed in any sequence.
	
	
	
	<b>5</b> Press the T3 button  to return to the doses programming.







## “Barista” Programming (available up to the 1.6.3 software version)

### Program Dose

Group Dose  
Settings

### Description

- This parameter allows the operator to program the amount of coffee (brewing amount) for each button on the keyboard.
- The brewing amount can be set in terms of time (sec. ) or pulses. This number refers to the number of pulses that the flowmeter sends to the CPU.
- Once programmed, the button remains lighted.



Display	Operating Procedure
<p>Group Dose Exit</p>	<p><b>6</b> Press T1  or T2  until the display shows the exit menu, press the T3 button  to return to the “Barista” programming.</p> <p><b>7</b> Press T1  or T2  to continue with the programming of the other parameters.</p>
<p>LaMarzocco 00:00 CB 93.8°C SB</p>	<p><b>8</b> Press T2  and T3  at the same time to exit the programming mode and return to the normal use of the espresso machine.</p>

## Program Dose

Group Dose  
Settings

### Description

- This parameter allows the operator to program the amount of coffee (brewing amount) for each button on the keyboard.
- The brewing amount can be set in terms of time (sec. ) or pulses. This number refers to the number of pulses that the flowmeter sends to the CPU.
- Once programmed, the button remains lighted.
- It is possible to set the dose for both a short and a long shot on the same key.
- The setting of the first group is automatically copied to the subsequent groups.
- It is possible to set each key individually, in this case the dose of the first group will no longer be used.
- It is possible to copy the doses of any key to the others.

Display	Operating Procedure
<p>LaMarzocco 00:00 CB 93.8°C SB</p>	<p><b>1</b> When the espresso machine is turned on, press and hold the T3 button  to access the “Barista” programming. After about 5 seconds the following screen is displayed.</p>
<p>Group Dose Settings</p>	<p><b>2</b> Press the T3 button  to enter the doses programming procedure.</p>
<p>Program Volume Dose</p>	<p><b>3</b> Press the T3 button  to start the doses programming procedure.</p>
<p>Press Enter To Exit</p>	<p><b>4</b> On each button you can set two doses, one for a short shot, one for a long shot.</p>
<p>Push To Stop 20 Pulses 1s</p>	<p>To set the brewing time of a short shot, press and release the button immediately, press again to stop and store the desired dose.</p>
<p>G1B1 Saved 20 Pulses</p>	<p>To set the brewing time of a long shot, press and hold the button for about 2 seconds, press and release the button immediately to store the desired dose.</p> <p>The two doses of each key can be set independently from one another.</p> <p>If one of the two doses is not set or does not refer to the corresponding dose of the first group, it will work as continuous dose.</p>









## “Barista” Programming (only on AV and ABR espresso machine models)

### Program Dose

Group Dose  
Settings

### Description

- This parameter allows the operator to program the amount of coffee (brewing amount) for each button on the keyboard.
- The brewing amount can be set in terms of time (sec. ) or pulses. This number refers to the number of pulses that the flowmeter sends to the CPU.
- Once programmed, the button remains lighted.
- It is possible to set the dose for both a short and a long shot on the same key.
- The setting of the first group is automatically copied to the subsequent groups.
- It is possible to set each key individually, in this case the dose of the first group will no longer be used.
- It is possible to copy the doses of any key to the others.



Display	Operating Procedure
Press Enter To Exit	<b>5</b> Press the T3 button  to return to the doses programming.
Group Dose Exit	<b>6</b> Press T1  or T2  until the display shows the exit menu, press the T3 button  to return to the “Barista” programming.
	<b>7</b> Press T1  or T2  to continue with the programming of the other parameters.
LaMarzocco 00:00 CB 93.8°C SB	<b>8</b> Press T2  and T3  at the same time to exit the programming mode and return to the normal use of the espresso machine.

## Program Dose Scales

Group Dose Settings

### Description

- This parameter allows the operator to program the amount of coffee (brewing weight) for each button on the keyboard.
- Once programmed, the button remains lighted.
- It is possible to set the dose for both a short and a long shot on the same key.
- It is possible to copy the doses of any key to the others.

Display	Operating Procedure
LaMarzocco 00:00 CB 93.8°C SB	<b>1</b> When the espresso machine is turned on, press and hold the T3 button  to access the “Barista” programming. After about 5 seconds the following screen is displayed.
Group Dose Settings	<b>2</b> Press the T3 button  to enter the doses programming procedure.
Program Mass Dose	<b>3</b> Press the T3 button  to start the doses programming procedure.
Press Enter To Exit	<b>4</b> On each button you can set two doses, one for a short shot, one for a long shot. To set the brewing weight of a short shot, press and release the button immediately, press again to stop and store the desired dose. To set the brewing weight of a long shot, press and hold the button for about 2 seconds, press and release the button immediately to store the desired dose. The two doses of each key can be set independently from one another.
Push To Stop 20.0g	
G1B1 Saved 20.0g	









## “Barista” Programming (only on AV and ABR espresso machine models)

### Program Dose Scales

Group Dose Settings

### Description

- This parameter allows the operator to program the amount of coffee (brewing weight) for each button on the keyboard.
- Once programmed, the button remains lighted.
- It is possible to set the dose for both a short and a long shot on the same key.
- It is possible to copy the doses of any key to the others.

Display	Operating Procedure
Press Enter To Exit	<b>5</b> Press the T3 button  to return to the doses programming.
Group Dose Exit	<b>6</b> Press T1  or T2  until the display shows the exit menu, press the T3 button  to return to the “Barista” programming.
	<b>7</b> Press T1  or T2  to continue with the programming of the other parameters.
LaMarzocco 00:00 CB 93.8°C SB	<b>8</b> Press T2  and T3  at the same time to exit the programming mode and return to the normal use of the espresso machine.











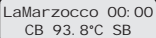

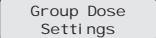
## Program Dose Scales

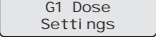
Group Dose Settings

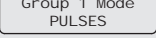
### Description

- This parameter allows the operator to select the coffee brewing mode among those available: pulse, mass and brew ratio.
- PULSE mode: control of doses in volume
- MASS mode: control of doses in mass
- BREW RATIO mode: ratio between the coffee powder and the weight of the drink

Display	Operating Procedure
	<b>1</b> When the espresso machine is turned on, press and hold the T3 button  to access the “Barista” programming. After about 5 seconds the following screen is displayed.
	<b>2</b> Press the T3 button  to enter the doses programming procedure.
	<b>3</b> Press the button T1  or T2  to display the following menu.
	<b>4</b> Press the T3 button  to access the menu, then navigate using T1  and T2  to choose between PULSES, MASS and BREWRATIO.







## “Barista” Programming (only on ABR espresso machine models)

### Program Dose Scales

Group Dose Settings

### Description

- This parameter allows the operator to select the coffee brewing mode among those available: pulse, mass and brew ratio.
- PULSE mode: control of doses in volume
- MASS mode: control of doses in mass
- BREW RATIO mode: ratio between the coffee powder and the weight of the drink











Display	Operating Procedure
<div data-bbox="122 591 274 635" style="border: 1px solid black; padding: 2px; text-align: center;">Exit Group 1</div>	<p><b>5</b> Press T1  or T2  until the display shows the exit menu, press the T3 button  to return to the “Barista” programming.</p> <p><b>6</b> Press T1  or T2  to continue with the programming of the other parameters.</p>
<div data-bbox="122 771 274 816" style="border: 1px solid black; padding: 2px; text-align: center;">LaMarzocco 00:00 CB 93.8°C SB</div>	<p><b>7</b> Press T2  and T3  at the same time to exit the programming mode and return to the normal use of the espresso machine.</p>

## Program Dose

G1 Dose  
Settings

### Description

- This parameter allows the operator to view and manually change each dose for each key.
- For greater accuracy and consistency of the doses, it is recommended that you set each key.
- The dose can be set by pulses or by mass (weight).

Display	Operating Procedure
LaMarzocco 00:00 CB 93.8°C SB	<b>1</b> When the espresso machine is turned on, press and hold the T3 button  to access the “Barista” programming. After about 5 seconds the following screen is displayed.
Group Dose Settings	<b>2</b> Press the T3 button  to enter the doses programming procedure.
Program Volume Dose	<b>3</b> Press the button T1  or T2  to display the following menu.
G1 Dose Settings	<b>4</b> Press the button T3  view and/or change the dose of each key.
G1B1 Dose 263 Pul ses	<b>5</b> Press the button T1  or T2  to view the dose of each key. Pressing the button T3  , the dose value will blink. Use the button T1  or T2  to change the value, press the button T3  to confirm the desired value.  It is possible to set the value of the pulses to zero to choose a continuous dose.
G1B1 Long Dose 363 Pul ses	
G1B1 Dose Conti nuous	
G1B3 Mode CONTI NUOUS	











## “Barista” Programming (only on AV and ABR espresso machine models)

### Program Dose

#### G1 Dose Settings

### Description

- This parameter allows the operator to view and manually change each dose for each key.
- For greater accuracy and consistency of the doses, it is recommended that you set each key.
- The dose can be set by pulses or by mass (weight).















Display	Operating Procedure
G2B1 Dose Use Group 1	Except for the first group, you can set the function USE GROUP 1 for each key. This option allows to use the corresponding dose of the first group instead of setting it.  The setting of the first group is automatically copied to the subsequent groups.
Mirror G1 Doses ENABLED	<b>6</b> Press the T3 button  to enter the menu, move using the buttons T1  and T2  to select ENABLED or DISABLED, press the T3 button  to confirm the option.
Exit Group 1	<b>7</b> Press the button T3  to exit the submenu.
Group Dose Exit	<b>8</b> Press the T3 button  to return to the doses programming.
	<b>9</b> Press T1  or T2  to continue with the programming of the other parameters.
LaMarzocco 00:00 CB 93.8°C SB	<b>10</b> Press T2  and T3  at the same time to exit the programming mode and return to the normal use of the espresso machine.

## Program Dose

G1 Dose  
Settings

### Description

- This parameter allows the operator to view and manually change each dose for each key.
- For greater accuracy and consistency of the doses, it is recommended that you set each key.
- The dose can be set by pulses or by mass (weight).

Display	Operating Procedure
LaMarzocco 00:00 CB 93.8°C SB	<p><b>1</b> When the espresso machine is turned on, press and hold the T3 button  to access the “Barista” programming. After about 5 seconds the following screen is displayed.</p>
Group Dose Settings	
Program Volume Dose	<p><b>2</b> Press the T3 button  to enter the doses programming procedure.</p> <p><b>3</b> Press the button T1  or T2  to display the following menu.</p>
G1 Dose Settings	
G1B1 Mass 20.0g	<p><b>4</b> Press the button T3  view and/or change the dose of each key.</p> <p><b>5</b> Press the button T1  or T2  to view the dose of each key. Pressing the button T3 , the dose value will blink. Use the button T1  or T2  to change the value, press the button T3  to confirm the desired value.</p> <p>It is possible to set the value of the pulses to zero to choose a continuous dose.</p> <p>Press the button T3  to enter the menu, then navigate using T1  and T2  to choose between CONTINUOUS or 3 SEC RINS.</p>
G1B1 Long Mass 30.0g	
G1B1 Mass 0.0g	
G1T3 Mode CONTINUOUS	







## “Barista” Programming (only on ABR espresso machine models)

### Program Dose

#### G1 Dose Settings

### Description

- This parameter allows the operator to view and manually change each dose for each key.
- For greater accuracy and consistency of the doses, it is recommended that you set each key.
- The dose can be set by pulses or by mass (weight).

















Display	Operating Procedure
Exit Group 1	<b>6</b> Press the button T3  to exit the submenu.
Group Dose Exit	<b>7</b> Press the T3 button  to return to the doses programming.
	<b>8</b> Press T1  or T2  to continue with the programming of the other parameters.
LaMarzocco 00:00 CB 93.8°C SB	<b>9</b> Press T2  and T3  at the same time to exit the programming mode and return to the normal use of the espresso machine.

## Program Dose Scales

G1 Dose Settings

### Description

- This parameter allows the operator to view and manually change each dose for each key.
- For greater accuracy and consistency of the doses, it is recommended that you set each key.

Display	Operating Procedure
LaMarzocco 00:00 CB 93.8°C SB	<ol style="list-style-type: none"> <li>1 When the espresso machine is turned on, press and hold the T3 button  to access the “Barista” programming. After about 5 seconds the following screen is displayed.</li> <li>2 Press the T3 button  to enter the doses programming procedure.</li> <li>3 Press the button T1  or T2  to display the following menu.</li> <li>4 Press the button T3  view and/or change the dose of each key.</li> <li>5 Press the button T1  or T2  to view the dose of each key. Pressing the button T3 , the dose value will blink. Use the button T1  or T2  to change the value, press the button T3  to confirm the desired value.</li> <li>6 Press the button T1  or T2  to view the portafilter mass of each group. Pressing the button T3 , the value will blink. Use the button T1  or T2  to change the value, press the button T3  to confirm the desired value.</li> </ol>
Group Dose Settings	
Program Volume Dose	
G1 Dose Settings	
G1B1 Brew Ratio 1:2.00	
G1 PF Mass 800.0g	











## “Barista” Programming (only on ABR espresso machine models)

### Program Dose Scales

G1 Dose Settings

### Description

- This parameter allows the operator to view and manually change each dose for each key.
- For greater accuracy and consistency of the doses, it is recommended that you set each key.

Display	Operating Procedure
G1 Coffee Mass 14.0g	<b>7</b> Press the button T1  or T2  to view the coffee mass of each group. Pressing the button T3  , the value will blink. Use the button T1  or T2  to change the value, press the button T3  to confirm the desired value.
G1B3 Mode CONTINUOUS	Press the button T3  to enter the menu, then navigate using T1  and T2  to choose between CONTINUOUS or 3 SEC RINS.
Exit Group 1	<b>8</b> Press the button T3  to exit the submenu.
Group Dose Exit	<b>9</b> Press the T3 button  to return to the doses programming.







## Program Dose Scales

G1 Dose Settings

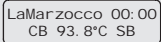
### Description

- This parameter allows the operator to view and manually change each dose for each key.
- For greater accuracy and consistency of the doses, it is recommended that you set each key.
- The dose can be set by pulses or by mass (weight).

Display	Operating Procedure
	<p><b>10</b> Press T1  or T2  to continue with the programming of the other parameters.</p> <p><b>11</b> Press T2  and T3  at the same time to exit the programming mode and return to the normal use of the espresso machine.</p>





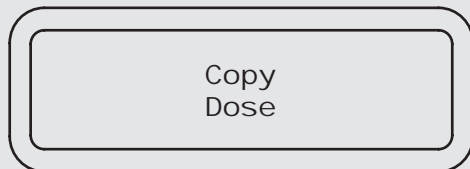



## “Barista” Programming (only on AV and ABR espresso machine models)

### Program Dose



### Description

- This parameter allows the operator to copy the doses present of each key to the others.





Display	Operating Procedure
LaMarzocco 00:00 CB 93.8°C SB	<b>1</b> When the espresso machine is turned on, press and hold the T3 button  to access the “Barista” programming. After about 5 seconds the following screen is displayed.
Group Dose Settings	<b>2</b> Press the T3 button  to enter the doses programming procedure.
Program Volume Dose	<b>3</b> Press the button T1  or T2  to display the following menu.
Copy Dose	<b>4</b> Press the button T3  to start the dose copy procedure.
Push Button to Copy	<b>5</b> Press the key whose setting you want to copy. Now all the keys will flash.
Push to Paste Enter to Exit	<b>6</b> Press the key where you want to paste the previously copied setting. Successful programming is indicated by the fixed lighting of the key. It is possible to repeat this procedure on any key.
Group Dose Exit	<b>7</b> Press T1  or T2  until the display shows the exit menu, press the T3 button  to return to the “Barista” programming.

## Program Dose

### Description

Copy  
Dose

- This parameter allows the operator to copy the doses present of each key to the others.

Display	Operating Procedure
<p>LaMarzocco 00:00 CB 93.8°C SB</p>	<p><b>8</b> Press T1  or T2  to continue with the programming of the other parameters.</p> <p><b>9</b> Press T2  and T3  at the same time to exit the programming mode and return to the normal use of the espresso machine.</p>









## “Barista” Programming (only on AV and ABR espresso machine models)

### Program Dose

### Description

Reset  
Volume Doses

- This parameter allows the operator to cancel all the doses set.





Display	Operating Procedure
LaMarzocco 00:00 CB 93.8°C SB	<b>1</b> When the espresso machine is turned on, press and hold the T3 button  to access the “Barista” programming. After about 5 seconds the following screen is displayed.
Group Dose Settings	<b>2</b> Press the T3 button  to enter the doses programming procedure.
Program Volume Dose	<b>3</b> Press the button T1  or T2  to display the following menu.
Reset Volume Doses	<b>4</b> Press the button T3  to confirm the procedure.
Resetting Doses...	<b>5</b> Now all settings are cleared.
Group Dose Exit	<b>6</b> Press T1  or T2  until the display shows the exit menu, press the T3 button  to return to the “Barista” programming.

## Program Dose

### Description

- This parameter allows the operator to cancel all the doses set.

Reset  
Volume Doses

Display	Operating Procedure
<p>LaMarzocco 00:00 CB 93.8°C SB</p>	<p><b>7</b> Press T1  or T2  to continue with the programming of the other parameters.</p> <p><b>8</b> Press T2  and T3  at the same time to exit the programming mode and return to the normal use of the espresso machine.</p>









## “Barista” Programming (only on AV and ABR espresso machine models)

### Program Scales

Scales  
Configuration

### Description

- This parameter enables the technician to set some scale parameters like:
  - Enabling/disabling the offset parameter;
  - Setting the weight reading time;
  - Calibrating the scales.





Display	Operating Procedure
LaMarzocco 00:00 CB 93.8°C SB	<b>1</b> When the espresso machine is turned on, press and hold the T3 button  to access the “Barista” programming. After about 5 seconds the following screen is displayed.
Scales Configuration	<b>2</b> Press the T3 button  to enter the doses programming procedure.
Scale B1 short Stop 0.7g early	<b>3</b> Press the T3 button  to enter the menu, then navigate using the T1  and T2  buttons to set the desired value. This parameter is common to all groups.
Scale B1 long Stop 0.7g early	
Scale Tare Time 3.0s	<b>4</b> Press the T3 button  to enter the menu, navigate the parameters using the buttons T1  and T2  to set the desired value. This parameter is common to all groups.
Start Scale Testing	<b>5</b> Press the T3 button  to enter the menu and place the reference weights onto the scale.
100 0.0 100 Enter to Exit	

## Program Scales

### Scales Configuration

#### Description

- This parameter enables the technician to set some scale parameters like:
  - Enabling/disabling the offset parameter;
  - Setting the weight reading time;
  - Calibrating the scales.

Display	Operating Procedure
Scale Settings Exit	<b>6</b> Press the T3 button  to return to the “Barista” programming.
	<b>7</b> Press T1  or T2  to continue with the programming of the other parameters.
LaMarzocco 00:00 CB 93.8°C SB	<b>8</b> Press T2  and T3  at the same time to exit the programming mode and return to the normal use of the espresso machine.











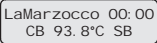

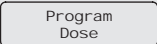



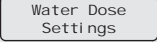

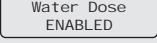
## “Barista” Programming

### Water Dose

Water Dose  
Settings

### Description

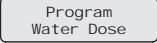
- This parameter allows the operator to program the amount of water (brewing amount) for the hot water button.
- This feature can be enabled or disabled.

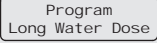
Display	Operating Procedure
	<b>1</b> When the espresso machine is turned on, press and hold the T3 button   to access the “Barista” programming. After about 5 seconds the following screen is displayed.
	<b>2</b> Move between the parameters using the buttons T1   or T2   until the display shows:
	<b>3</b> Press the T3 button   to enter the menu.
	<b>4</b> Press the T3 button   to enter the menu, move between the parameters using the buttons T1   and T2   to select ENABLED or DI SABLED , press the T3 button T3   to confirm the option.
	<b>5</b> You can set two doses on the hot water button by selecting either Water Dose or Long Water Dose. Press T3   to start the dose setting procedure.
	















## Water Dose

### Description

- This parameter allows the operator to program the amount of water (brewing amount) for the hot water button.
- This feature can be enabled or disabled.

Water Dose  
Settings

Display	Operating Procedure
<p>Press Water Button To Stop</p> <p>Press Water Button To Program</p> <p>Water Dose Saved 5.0 Seconds</p>	<p><b>6</b> To program the brewing time, press the hot water button to start and then press it again to stop when the desired dose is achieved.</p> <p>Now the saved brewing time is displayed.</p>
<p>Water Dose 5.0s</p>	<p><b>7</b> Press T1  ◀ or T2  ▶ to display the dose of the hot water button. Pressing the button T3 , the dose value will blink. Use the button T1  ◀ or T2  ▶ to change the value, press the button T3  to confirm the desired value.</p>
<p>Long Water Dose 10.0s</p>	<p><b>8</b> Press T1  ◀ or T2  ▶ to display the long dose of the hot water button. Pressing the button T3 , the dose value will blink. Use the button T1  ◀ or T2  ▶ to change the value, press the button T3  to confirm the desired value.</p>











## “Barista” Programming

### Water Dose

Water Dose  
Settings

### Description

- This parameter allows the operator to program the amount of water (brewing amount) for the hot water button.
- This feature can be enabled or disabled.

























Display	Operating Procedure
<p>Water Dose Exit</p>	<p><b>9</b> Press the T3 button   to return to the “Barista” programming.</p> <p><b>10</b> Press T1   or T2   to continue with the programming of the other parameters.</p>
<p>LaMarzocco 00:00 CB 93.8°C SB</p>	<p><b>11</b> Press T2   and T3   at the same time to exit the programming mode and return to the normal use of the espresso machine.</p>

## Coffee Boiler

Coffee Boiler  
Settings

### Description

- This parameter allows the operator to enable/disable the coffee boiler.
- This parameter allows the operator to program the coffee boiler temperature. Each group can have a different programming.
- For an espresso machine composed of 2 and 3 groups you can only set the coffee boiler 1, while for an espresso machine with 4 groups you can also set the coffee boiler 2.

Display	Operating Procedure
LaMarzocco 00:00 CB 93.8°C SB	<b>1</b> When the espresso machine is turned on, press and hold the T3 button   to access the “Barista” programming. After about 5 seconds the following screen is displayed.
Program Dose	<b>2</b> Move between the parameters using the buttons T1   and T2   until the display shows:
Coffee Boiler Settings	<b>3</b> Press the T3 button   to enter the menu.
Coffee Boiler 1 ENABLED	<b>4</b> Press the T3 button   to enter the menu, move between the parameters using the buttons T1   and T2   to select ENABLED or DI SABLED, press the T3 button   to confirm the option. In the case of option enabled you can set the following parameters.
CB1 Temperature 93.1°C 93.3°C	<b>5</b> Press the T3 button   to enter the menu, move with the buttons T1   and T2   to set the desired temperature, press the T3 button   to confirm the value. In the case of espresso machine a multiple boilers you can set the temperature also on the coffee boiler. The temperature indicated on the left is the actual temperature of the group while the temperature on the right is the set temperature.















## “Barista” Programming

### Coffee Boiler

Coffee Boiler  
Settings

### Description

- This parameter allows the operator to enable/disable the coffee boiler.
- This parameter allows the operator to program the coffee boiler temperature. Each group can have a different programming.
- For an espresso machine composed of 2 and 3 groups you can only set the coffee boiler 1, while for an espresso machine with 4 groups you can also set the coffee boiler 2.

Display	Operating Procedure
<div data-bbox="122 587 274 630" style="border: 1px solid black; padding: 2px; margin-bottom: 10px;">                     CB Settings Exit                 </div>	<p><b>6</b> To exit the menu move between the parameters using the buttons T1   and T2   until the exit menu is displayed. Press the T3 button   to return to the “Barista” programming.</p> <p><b>7</b> Press T1   or T2   to continue with the programming of the other parameters.</p>
<div data-bbox="122 768 274 811" style="border: 1px solid black; padding: 2px;">                     LaMarzocco 00:00 CB 93.8°C SB                 </div>	<p><b>8</b> Press T2   and T3   at the same time to exit the programming mode and return to the normal use of the espresso machine.</p>

## Pre-Infusion or Pre-Brewing



































Pre-Inf  
Settings

### Description

- This parameter allows the operator to program the time of pre-brewing of water with the coffee. Each group can have a different programming.
- Pre-brewing has only two values to be adjusted for each group. The time (in seconds) for which the brewing valve is open during the pre-brewing cycle and the time (in seconds) for which the brewing valve is closed during the

pre-brewing cycle; during this time the pump is active. Once the pre-brewing cycle is over, the normal brewing cycle will continue until the end.

- For an espresso machine composed of three groups, they are identified as Group 1, Group 2 and Group 3.

Display	Operating Procedure
LaMarzocco 00:00 CB 93.8°C SB	<ol style="list-style-type: none"> <li>1 When the espresso machine is turned on, press and hold the T3 button   to access the “Barista” programming. After about 5 seconds the following screen is displayed.</li> <li>2 Move between the parameters using the buttons T1   and T2   until the display shows:</li> <li>3 Press the T3 button   to enter the menu.</li> <li>4 Press T1   or T2   to select the group whose parameters you want to set. By pressing the T3 button   the first value will blink. Use the buttons T1   and T2   to reach the value that you want to set, press T3   to confirm. Repeat this operation to set the second value.</li> <li>5 To exit the menu move between the parameters using the buttons T1   and T2   until the exit menu is displayed. Press the T3 button   to exit the menu.</li> <li>6 Press T1   or T2   to continue with the programming of the other parameters.</li> <li>7 Press T2   and T3   at the same time to exit the programming mode and return to the normal use of the espresso machine.</li> </ol>
Program Dose	
Pre-Inf Settings	
Group 1 Pre-Inf 0s Wet 0s Hold	
Pre-Inf Settings Exit	
LaMarzocco 00:00 CB 93.8°C SB	















## “Barista” Programming

### Cup Warmer

Cup Warmer  
DI SABLED

### Description

- This parameter allows the operator to enable or disable the cups heating function.
- This function is displayed only on the models of espresso machine equipped with this accessory.



Display	Operating Procedure
<p>LaMarzocco 00:00 CB 93.8°C SB</p>	<p><b>1</b> When the espresso machine is turned on, press and hold the T3 button  . After about 5 seconds the following screen is displayed.</p>
<p>Program Dose</p>	<p><b>2</b> Move between the parameters using the buttons T1   and T2   until the display shows:</p>
<p>Cup Warmer DI SABLED</p>	<p><b>3</b> Press the T3 button   to enter the menu, move between the parameters using the buttons T1   and T2   to select ENABLED or DI SABLED , press the T3 button   to confirm the option.</p>

## Exit Menu

### Description

- This parameter allows the operator to exit the “Barista” programming and return to the normal use of the espresso machine.

Menu  
Press B3 to Exit

Display	Operating Procedure
<p>Menu Press B3 to Exit</p>	<p><b>1</b> Press the T3 button  to exit the “Barista” programming and return to the normal use of the espresso machine.</p>
<p>LaMarzocco 00:00 CB 93.8°C SB</p>	<p><b>2</b> Alternatively, you can exit the “Barista” programming and return to the normal use of the espresso machine by pressing T2  and T3  at the same time.</p>































## “Technical” Programming

### Language

### Description

- This parameter allows the technician to change the language of the display.

Language  
ENGLISH

Display	Operating Procedure
LaMarzocco 00:00 CB 93.8°C SB	<ol style="list-style-type: none"> <li>When the espresso machine is turned on, press and hold the T3 button  . After about 10 seconds the following screen is displayed.</li> <li>Enter the technician password using the buttons T1  , T2   and T3  . After the acceptance, the following screen is displayed.</li> <li>Press the T3 button   to enter the menu, move between the parameters using the buttons T1   and T2   to select a language, press the T3 button   to confirm the option.</li> <li>Press T1   or T2   to continue with the programming of the other parameters.</li> <li>To exit the menu move between the parameters using the buttons T1   and T2   until the exit menu is displayed. Press the T3 button   to exit the menu and return to the normal use of the espresso machine.</li> <li>Alternatively, you can exit the “Technical” programming and return to the normal use of the espresso machine by pressing T2   and T3   at the same time.</li> </ol>
Enter Password *****	
Language ENGLISH	
Technician Menu Press B3 to Exit	
LaMarzocco 00:00 CB 93.8°C SB	



















## Temperature Measurement Units

Temp Units  
CELSIUS

### Description

- This parameter allows the technician to change the temperature display from degrees Celsius to degrees Fahrenheit and vice versa.





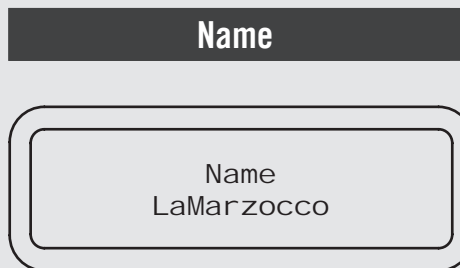















Display	Operating Procedure
Enter Password *****	<b>1</b> After accessing the “Technical” programming menu and entering the password, use the buttons T1   and T2  until the following screen is displayed.
Temp Units CELSIUS	<b>2</b> Press the T3 button  to enter the menu, move between the parameters using the buttons T1   and T2  to select an option, press the T3 button  to confirm the option.
	<b>3</b> Press T1   or T2  to continue with the programming of the other parameters.
Technician Menu Press B3 to Exit	<b>4</b> To exit the menu move between the parameters using the buttons T1   and T2  until the exit menu is displayed. Press the T3 button  to exit the menu and return to the normal use of the espresso machine.
LaMarzocco 00:00 CB 93.8°C SB	<b>5</b> Alternatively, you can exit the “Technical” programming and return to the normal use of the espresso machine by pressing T2  and T3  at the same time.

## “Technical” Programming



### Description

- This parameter allows the technician to program a 16 character user name.
- The user name is displayed continuously on the display on the second line.





Display	Operating Procedure
Enter Password *****	<b>1</b> After accessing the “Technical” programming menu and entering the password, use the buttons T1   and T2  until the following screen is displayed.
Name LaMarzocco	<b>2</b> Press the T3 button   to enter the menu, use the buttons T1   and T2  to set the desired value, press the T3 button   to confirm the value and proceed with writing.  Press T1   or T2  to continue with the programming of the other parameters.
Techni ci an Menu Press B3 to Exit	<b>3</b> To exit the menu move between the parameters using the buttons T1   and T2  until the exit menu is displayed. Press the T3 button   to exit the menu and return to the normal use of the espresso machine.
LaMarzocco 00:00 CB 93.8°C SB	<b>4</b> Alternatively, you can exit the “Technical” programming and return to the normal use of the espresso machine by pressing T2  and T3   at the same time.
	<b>5</b>

## Program Dose

Group Dose  
Settings

### Description

- This parameter allows the operator to program the amount of coffee (brewing amount) for each button on the keyboard.
- The brewing amount can be set in terms of time (sec. ) or pulses. This number refers to the number of pulses that the flowmeter sends to the CPU.
- Once programmed, the button remains lighted.

Display	Operating Procedure
LaMarzocco 00:00 CB 93.8°C SB	<ol style="list-style-type: none"> <li>1 After accessing the “Technical” programming menu and entering the password, use the buttons T1  and T2  until the following screen is displayed.</li> <li>2 Press the T3 button  to enter the doses programming procedure.</li> <li>3 Press the T3 button  to start the doses programming procedure.</li> <li>4 To program the coffee brewing time, press the dose button to start and then press it again to stop, once the desired dose is achieved. Successful programming is indicated by the lighting of the button. This operation must be repeated for each button whose dose you want to set. The buttons can be programmed in any sequence.</li> </ol>
Group Dose Settings	
Program Volume Dose	
Press Enter To Exit	
Press b To Stop 10 pulses	
G1B1 Saved 10 Pulses	<ol style="list-style-type: none"> <li>5 Press the T3 button  to return to the doses programming.</li> </ol>
Press Enter To Exit	







## “Technical” Programming (available up to the 1.6.3 software version)

### Program Dose

Group Dose  
Settings

### Description

- This parameter allows the operator to program the amount of coffee (brewing amount) for each button on the keyboard.
- The brewing amount can be set in terms of time (sec. ) or pulses. This number refers to the number of pulses that the flowmeter sends to the CPU.
- Once programmed, the button remains lighted.





Display	Operating Procedure
<p>Group Dose Exit</p>	<p><b>6</b> Press T1  or T2  until the display shows the exit menu, press the T3 button  to return to the “Technical” programming.</p> <p><b>7</b> Press T1  or T2  to continue with the programming of the other parameters.</p>
<p>LaMarzocco 00:00 CB 93.8°C SB</p>	<p><b>8</b> Press T2  and T3  at the same time to exit the programming mode and return to the normal use of the espresso machine.</p>

## Program Dose

Group Dose  
Settings

### Description

- This parameter allows the operator to program the amount of coffee (brewing amount) for each button on the keyboard.
- The brewing amount can be set in terms of time (sec. ) or pulses. This number refers to the number of pulses that the flowmeter sends to the CPU.
- Once programmed, the button remains lighted.
- It is possible to set the dose for both a short and a long shot on the same key.
- The setting of the first group is automatically copied to the subsequent groups.
- It is possible to set each key individually, in this case the dose of the first group will no longer be used.
- It is possible to copy the doses of any key to the others.

Display	Operating Procedure
<p>LaMarzocco 00:00 CB 93.8°C SB</p>	<p><b>1</b> After accessing the “Technical” programming menu and entering the password, use the buttons T1  and T2  until the following screen is displayed.</p>
<p>Group Dose Settings</p>	<p><b>2</b> Press the T3 button  to enter the doses programming procedure.</p>
<p>Program Volume Dose</p>	<p><b>3</b> Press the T3 button  to start the doses programming procedure.</p>
<p>Press Enter To Exit</p>	<p><b>4</b> On each button you can set two doses, one for a short shot, one for a long shot.</p>
<p>Push To Stop 20 Pulses 1s</p>	<p>To set the brewing time of a short shot, press and release the button immediately, press again to stop and store the desired dose.</p>
<p>G1B1 Saved 20 Pulses</p>	<p>To set the brewing time of a long shot, press and hold the button for about 2 seconds, press and release the button immediately to store the desired dose.</p> <p>The two doses of each key can be set independently from one another.</p> <p>If one of the two doses is not set or does not refer to the corresponding dose of the first group, it will work as continuous dose.</p>









## “Technical” Programming (only on AV and ABR espresso machine models)

### Program Dose

Group Dose  
Settings

### Description

- This parameter allows the operator to program the amount of coffee (brewing amount) for each button on the keyboard.
- The brewing amount can be set in terms of time (sec. ) or pulses. This number refers to the number of pulses that the flowmeter sends to the CPU.
- Once programmed, the button remains lighted.
- It is possible to set the dose for both a short and a long shot on the same key.
- The setting of the first group is automatically copied to the subsequent groups.
- It is possible to set each key individually, in this case the dose of the first group will no longer be used.
- It is possible to copy the doses of any key to the others.





Display	Operating Procedure
Press Enter To Exit	<b>5</b> Press the T3 button  to return to the doses programming.
Group Dose Exit	<b>6</b> Press T1  or T2  until the display shows the exit menu, press the T3 button  to return to the “Technical” programming.
	<b>7</b> Press T1  or T2  to continue with the programming of the other parameters.
LaMarzocco 00:00 CB 93.8°C SB	<b>8</b> Press T2  and T3  at the same time to exit the programming mode and return to the normal use of the espresso machine.

## Program Dose Scales

Group Dose Settings

### Description

- This parameter allows the operator to program the amount of coffee (brewing weight) for each button on the keyboard.
- Once programmed, the button remains lighted.
- It is possible to set the dose for both a short and a long shot on the same key.
- It is possible to copy the doses of any key to the others.

Display	Operating Procedure
LaMarzocco 00:00 CB 93.8°C SB	<b>1</b> After accessing the “Technical” programming menu and entering the password, use the buttons T1  and T2  until the following screen is displayed.
Group Dose Settings	<b>2</b> Press the T3 button  to enter the doses programming procedure.
Program Volume dose	<b>3</b> Press the T3 button  to start the doses programming procedure.
Press Enter To Exit	<b>4</b> On each button you can set two doses, one for a short shot, one for a long shot.
Push To Stop 20.0g	To set the brewing weight of a short shot, press and release the button immediately, press again to stop and store the desired dose.
G1B1 Saved 20.0g	To set the brewing weight of a long shot, press and hold the button for about 2 seconds, press and release the button immediately to store the desired dose.
	The two doses of each key can be set independently from one another.









## “Technical” Programming (only on ABR espresso machine models)

### Program Dose Scales

Group Dose Settings

### Description

- This parameter allows the operator to program the amount of coffee (brewing weight) for each button on the keyboard.
- Once programmed, the button remains lighted.
- It is possible to set the dose for both a short and a long shot on the same key.
- It is possible to copy the doses of any key to the others.

Display	Operating Procedure
Press Enter To Exit	<b>5</b> Press the T3 button  to return to the doses programming.
Group Dose Exit	<b>6</b> Press T1  or T2  until the display shows the exit menu, press the T3 button  to return to the “Technical” programming.
	<b>7</b> Press T1  or T2  to continue with the programming of the other parameters.
LaMarzocco 00:00 CB 93.8°C SB	<b>8</b> Press T2  and T3  at the same time to exit the programming mode and return to the normal use of the espresso machine.











## Program Dose Scales

Group Dose Settings

### Description

- This parameter allows the operator to select the coffee brewing mode among those available: pulse, mass and brew ratio.
- PULSE mode: control of doses in volume
- MASS mode: control of doses in mass
- BREW RATIO mode: ratio between the coffee powder and the weight of the drink

Display	Operating Procedure
LaMarzocco 00:00 CB 93.8°C SB	<b>1</b> After accessing the “Technical” programming menu and entering the password, use the buttons T1  and T2  until the following screen is displayed.
Group Dose Settings	<b>2</b> Press the T3 button  to enter the doses programming procedure.
G1 Dose Settings	<b>3</b> Press the button T1  or T2  to display the following menu.
Group 1 Mode PULSES	<b>4</b> Press the T3 button  to access the menu, then navigate using T1  and T2  to choose between PULSES, MASS and BREWRATIO.







## “Technical” Programming (only on ABR espresso machine models)

### Program Dose Scales

Group Dose Settings

### Description

- This parameter allows the operator to select the coffee brewing mode among those available: pulse, mass and brew ratio.
- PULSE mode: control of doses in volume
- MASS mode: control of doses in mass
- BREW RATIO mode: ratio between the coffee powder and the weight of the drink















Display	Operating Procedure
<p>Exit Group 1</p>	<p><b>5</b> Press T1  or T2  until the display shows the exit menu, press the T3 button  to return to the “Technical” programming.</p> <p><b>6</b> Press T1  or T2  to continue with the programming of the other parameters.</p>
<p>LaMarzocco 00:00 CB 93.8°C SB</p>	<p><b>7</b> Press T2  and T3  at the same time to exit the programming mode and return to the normal use of the espresso machine.</p>

## Program Dose

G1 Dose  
Settings

### Description

- This parameter allows the operator to view and manually change each dose for each key.
- For greater accuracy and consistency of the doses, it is recommended that you set each key.

Display	Operating Procedure
LaMarzocco 00:00 CB 93.8°C SB	<p><b>1</b> After accessing the “Technical” programming menu and entering the password, use the buttons T1  and T2  until the following screen is displayed.</p> <p><b>2</b> Press the T3 button  to enter the doses programming procedure.</p> <p><b>3</b> Press the button T1  or T2  to display the following menu.</p> <p><b>4</b> Press the button T3  view and/or change the dose of each key.</p> <p><b>5</b> Press the button T1  or T2  to view the dose of each key. Pressing the button T3 , the dose value will blink. Use the button T1  or T2  to change the value, press the button T3  to confirm the desired value.</p> <p>It is possible to set the value of the pulses to zero to choose a continuous dose.</p> <p>Press the button T3  to enter the menu, then navigate using T1  and T2  to choose between CONTINUOUS or 3 SEC RINS.</p>
Group Dose Settings	
Program Volume Dose	
G1 Dose Settings	
G1B1 Dose 263 Pul ses	
G1B1 Long Dose 363 Pul ses	
G1B1 Dose Continuous	
G1T3 Mode CONTINUOUS	











## “Technical” Programming (only on AV and ABR espresso machine models)

### Program Dose

G1 Dose  
Settings

### Description

- This parameter allows the operator to view and manually change each dose for each key.
- For greater accuracy and consistency of the doses, it is recommended that you set each key.















Display	Operating Procedure
G2B1 Dose Use Group 1	Except for the first group, you can set the function USE GROUP 1 for each key. This option allows to use the corresponding dose of the first group instead of setting it.  The setting of the first group is automatically copied to the subsequent groups.
Mirror G1 Doses ENABLED	<b>6</b> Press the T3 button  to enter the menu, move using the buttons T1  and T2  to select ENABLED or DISABLED, press the T3 button  to confirm the option.
Exit Group 1	<b>7</b> Press the button T3  to exit the submenu.
Group Dose Exit	<b>8</b> Press the T3 button  to return to the doses programming.
	<b>9</b> Press T1  or T2  to continue with the programming of the other parameters.
LaMarzocco 00:00 CB 93.8°C SB	<b>10</b> Press T2  and T3  at the same time to exit the programming mode and return to the normal use of the espresso machine.

## Program Dose

G1 Dose  
Settings

### Description

- This parameter allows the operator to view and manually change each dose for each key.
- For greater accuracy and consistency of the doses, it is recommended that you set each key.

Display	Operating Procedure
LaMarzocco 00:00 CB 93.8°C SB	<ol style="list-style-type: none"> <li>1 After accessing the “Technical” programming menu and entering the password, use the buttons T1  and T2  until the following screen is displayed.</li> <li>2 Press the T3 button  to enter the doses programming procedure.</li> <li>3 Press the button T1  or T2  to display the following menu.</li> <li>4 Press the button T3  view and/or change the dose of each key.</li> <li>5 Press the button T1  or T2  to view the dose of each key. Pressing the button T3 , the dose value will blink. Use the button T1  or T2  to change the value, press the button T3  to confirm the desired value. It is possible to set the value of the pulses to zero to choose a continuous dose. Press the button T3  to enter the menu, then navigate using T1  and T2  to choose between CONTI NUOUS or 3 SEC RI NS.</li> </ol>
Group Dose Settings	
Program Volume Dose	
G1 Dose Settings	
G1B1 Mass 20.0g	
G1B1 Long Mass 30.0g	
G1B1 Mass 0.0g	
G1T3 Mode CONTI NUOUS	









## “Technical” Programming (only on ABR espresso machine models)

### Program Dose

G1 Dose  
Settings

### Description

- This parameter allows the operator to view and manually change each dose for each key.
- For greater accuracy and consistency of the doses, it is recommended that you set each key.



















Display	Operating Procedure
Exit Group 1	<b>6</b> Press the button T3  to exit the submenu.
Group Dose Exit	<b>7</b> Press T1  or T2  until the display shows the exit menu, press the T3 button  to return to the “Technical” programming.
	<b>8</b> Press T1  or T2  to continue with the programming of the other parameters.
LaMarzocco 00:00 CB 93.8°C SB	<b>9</b> Press T2  and T3  at the same time to exit the programming mode and return to the normal use of the espresso machine.

## Program Dose Scales

G1 Dose Settings

### Description

- This parameter allows the operator to view and manually change each dose for each key.
- For greater accuracy and consistency of the doses, it is recommended that you set each key.

Display	Operating Procedure
LaMarzocco 00:00 CB 93.8°C SB	<ol style="list-style-type: none"> <li>1 After accessing the “Technical” programming menu and entering the password, use the buttons T1  and T2  until the following screen is displayed.</li> <li>2 Press the T3 button  to enter the doses programming procedure.</li> <li>3 Press the button T1  or T2  to display the following menu.</li> <li>4 Press the button T3  view and/or change the dose of each key.</li> <li>5 Press the button T1  or T2  to view the dose of each key. Pressing the button T3 , the dose value will blink. Use the button T1  or T2  to change the value, press the button T3  to confirm the desired value.</li> <li>6 Press the button T1  or T2  to view the portafilter mass of each group. Pressing the button T3 , the value will blink. Use the button T1  or T2  to change the value, press the button T3  to confirm the desired value.</li> </ol>
Group Dose Settings	
Program Volume Dose	
G1 Dose Settings	
G1B1 Brew Ratio 1:2.00	
G1 PF Mass 800.0g	













## “Technical” Programming (only on ABR espresso machine models)

### Program Dose Scales

G1 Dose Settings

### Description

- This parameter allows the operator to view and manually change each dose for each key.
- For greater accuracy and consistency of the doses, it is recommended that you set each key.

Display	Operating Procedure
G1 Coffee Mass 14.0g	<b>7</b> Press the button T1  or T2  to view the coffee mass of each group. Pressing the button T3  , the value will blink. Use the button T1  or T2  to change the value, press the button T3  to confirm the desired value.
G1T3 Mode CONTINUOUS	Press the button T3  to enter the menu, then navigate using T1  and T2  to choose between CONTINUOUS or 3 SEC RINS.
Exit Group 1	<b>8</b> Press the button T3  to exit the submenu.
Group Dose Exit	<b>9</b> Press T1  or T2  until the display shows the exit menu, press the T3 button  to return to the “Technical” programming.







## Program Dose Scales

G1 Dose Settings

### Description

- This parameter allows the operator to view and manually change each dose for each key.
- For greater accuracy and consistency of the doses, it is recommended that you set each key.
- The dose can be set by pulses or by mass (weight).

Display	Operating Procedure
<p>LaMarzocco 00:00 CB 93.8°C SB</p>	<p><b>10</b> Press T1  or T2  to continue with the programming of the other parameters.</p> <p><b>11</b> Press T2  and T3  at the same time to exit the programming mode and return to the normal use of the espresso machine.</p>





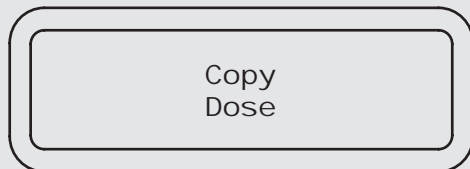



## “Technical” Programming (only on AV and ABR espresso machine models)

### Program Dose



### Description

- This parameter allows the operator to copy the doses present of each key to the others.





Display	Operating Procedure
LaMarzocco 00:00 CB 93.8°C SB	1 After accessing the “Technical” programming menu and entering the password, use the buttons T1  and T2  until the following screen is displayed.
Group Dose Settings	2 Press the T3 button  to enter the doses programming procedure.
Program Volume Dose	3 Press the button T1  or T2  to display the following menu.
Copy Dose	4 Press the button T3  to start the dose copy procedure.
Push Button to Copy	5 Press the key whose setting you want to copy. Now all the keys will flash.
Push to Paste Enter to Exit	6 Press the key where you want to paste the previously copied setting. Successful programming is indicated by the fixed lighting of the key. It is possible to repeat this procedure on any key.
Group Dose Exit	7 Press T1  or T2  until the display shows the exit menu, press the T3 button  to return to the “Technical” programming.

## Program Dose

### Description

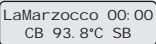
Copy  
Dose

- This parameter allows the operator to copy the doses present of each key to the others.

Display	Operating Procedure
	<p><b>8</b> Press T1  or T2  to continue with the programming of the other parameters.</p> <p><b>9</b> Press T2  and T3  at the same time to exit the programming mode and return to the normal use of the espresso machine.</p>





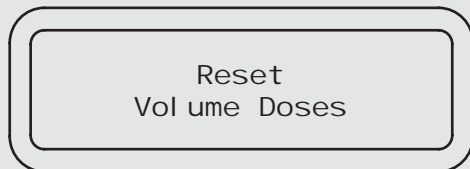



## “Technical” Programming (only on AV and ABR espresso machine models)

### Program Dose



### Description

- This parameter allows the operator to cancel all the doses set.





Display	Operating Procedure
LaMarzocco 00:00 CB 93.8°C SB	<b>1</b> After accessing the “Technical” programming menu and entering the password, use the buttons T1  and T2  until the following screen is displayed.
Group Dose Settings	<b>2</b> Press the T3 button  to enter the doses programming procedure.
Program Volume Dose	<b>3</b> Press the button T1  or T2  to display the following menu.
Reset Volume Doses	<b>4</b> Press the button T3  to confirm the procedure.
Resetting Doses...	<b>5</b> Now all settings are cleared.
Group Dose Exit	<b>6</b> Press T1  or T2  until the display shows the exit menu, press the T3 button  to return to the “Technical” programming.

## Program Dose

### Description

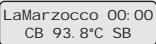
- This parameter allows the operator to cancel all the doses set.

Reset  
Volume Doses

Display	Operating Procedure
	<p><b>7</b> Press T1  or T2  to continue with the programming of the other parameters.</p> <p><b>8</b> Press T2  and T3  at the same time to exit the programming mode and return to the normal use of the espresso machine.</p>

## “Technical” Programming (only on AV and ABR espresso machine models)

### Program Dose

### Description

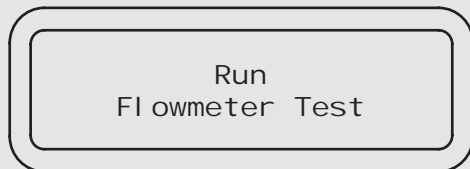

- This parameter enables the technician to check of the flowmeter.







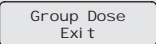

Display	Operating Procedure
	<p><b>1</b> After accessing the “Technical” programming menu and entering the password, use the buttons T1  and T2  until the following screen is displayed.</p>
	<p><b>2</b> Press the T3 button  to enter the doses programming procedure.</p>
	<p><b>3</b> Press the button T1  or T2  to display the following menu.</p>
	<p><b>4</b> Press the button T3  to confirm the procedure.</p>

## Program Dose

### Description

- This parameter enables the technician to check of the flowmeter.

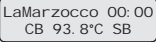
Run  
Flowmeter Test

Display	Operating Procedure
	<p><b>5</b> Press T1  or T2  until the display shows the exit menu, press the T3 button  to return to the “Technical” programming.</p>
	<p><b>6</b> Press T1  or T2  to continue with the programming of the other parameters.</p>
	<p><b>7</b> Press T2  and T3  at the same time to exit the programming mode and return to the normal use of the espresso machine.</p>











## “Technical” Programming (only on ABR espresso machine models)

### Program Scales

Scales  
Configuration

### Description

- This parameter enables the technician to set some scale parameters like:
  - Enabling/disabling the offset parameter;
  - Setting the weight reading time;
  - Calibrating the scales;
  - Updating the scale software.

Display	Operating Procedure
LaMarzocco 00:00 CB 93.8°C SB	1 After accessing the “Technical” programming menu and entering the password, use the buttons T1  and T2  until the following screen is displayed.
Scales Configuration	2 Press the T3 button  to enter the doses programming procedure.
Scale B1 short Stop 0.7g early	3 Press the T3 button  to enter the menu, then navigate using the T1  and T2  buttons to set the desired value. This parameter is common to all groups.
Scale B1 long Stop 0.7g early	
Scale Tare Time 3.0s	4 Press the T3 button  to enter the menu, navigate the parameters using the buttons T1  and T2  to set the desired value. This parameter is common to all groups.
G1 Scale PRESENT	5 This parameter indicates that the scale is properly connected; navigate using the T1  and T2  buttons to display the next menu.











## Program Scales

### Scales Configuration

#### Description

- This parameter enables the technician to set some scale parameters like:
  - Enabling/disabling the offset parameter;
  - Setting the weight reading time;
  - Calibrating the scales;
  - Updating the scale software.

Display	Operating Procedure
Calibrate Scales Empty G1 Scale And Press Enter Place 100g on G1 And Press Enter G1 Scale: v2.5.2 Upgrade to 2.5.2	<b>6</b> Press the T3 button  to start the calibration procedure. Remove any object from the scale, then press the T3 button  to confirm. Place the reference weights onto the scale, then press the T3 button  to confirm. At the end of the process, the self-calibration values or a confirmation message are displayed. Repeat this operation for each group.
Start Scale Testing  Enter to Exit 0.0 0.0 0.0 Enter to Exit	<b>7</b> Press T2  to proceed with setting and press the T3  button to update the scale firmware if necessary.
View Scale Versions	<b>8</b> Press T3  to start the test procedure.  Now you can put any weight on the scale to verify its operation.
	<b>9</b> Press the button T3  to enter the menu.













## “Technical” Programming (only on ABR espresso machine models)

### Program Scales

Scales  
Configuration

### Description

- This parameter enables the technician to set some scale parameters like:
  - Enabling/disabling the offset parameter;
  - Setting the weight reading time;
  - Calibrating the scales;
  - Updating the scale software.





















Display	Operating Procedure
G1 Scale HW3.0 FW2.5.2	<b>10</b> Use T1  and T2  to display the hardware and software version installed.
View Versions Exit	<b>11</b> Press T3  to exit the submenu.
Scale Settings Exit	<b>12</b> To exit the submenu move between the parameters using the buttons T1  and T2  until the exit submenu is displayed. Press the T3 button  to exit the submenu.
Technician Menu Press B3 to Exit	<b>13</b> Press T1  or T2  to continue with the programming of the other parameters.
LaMarzocco 00:00 CB 93.8°C SB	<b>14</b> To exit the menu move between the parameters using the buttons T1  and T2  until the exit menu is displayed. Press the T3 button  to exit the menu and return to the normal use of the espresso machine.
	<b>15</b> Alternatively, you can exit the “Technical” programming and return to the normal use of the espresso machine by pressing T2  and T3  at the same time. It is advisable to turn off and on the espresso machine.

## Water Dose

### Description

Water Dose  
Settings

- This parameter allows the operator to program the amount of water (brewing amount) for the hot water button.
- This feature can be enabled or disabled.

Display	Operating Procedure
Enter Password *****	<b>1</b> After accessing the “Technical” programming menu and entering the password, use the buttons T1   and T2  until the following screen is displayed.
Water Dose Settings	<b>2</b> Press the T3 button   to enter the menu.
Water With Pump WI TH PUMP	<b>3</b> Press the T3 button   to enter the menu, move using the buttons T1   and T2  to select WI TH PUMP or WI THOUT PUMP, press the T3 button   to confirm the option.
Water Dose ENABLED	<b>4</b> Press the T3 button   to enter the menu, move between the parameters using the buttons T1   and T2  to select ENABLED or DI SABLED , press the T3 button   to confirm the option.
Program Water Dose	<b>5</b> You can set two doses on the hot water button by selecting either Water Dose or Long Water Dose. Press T3   to start the dose setting procedure.
Program Long Water Dose	





















## “Technical” Programming

### Water Dose

Water Dose  
Settings

### Description

- This parameter allows the operator to program the amount of water (brewing amount) for the hot water button.
- This feature can be enabled or disabled.

















Display	Operating Procedure
<p>Program Water Dose</p> <p>Press Water Button To Stop</p> <p>Press Water Button To Program</p> <p>Water Dose Saved 5.0 Seconds</p>	<p><b>6</b> To program the brewing time, press the hot water button to start and then press it again to stop when the desired dose is achieved.</p> <p>Now the saved brewing time is displayed.</p>
<p>Water Dose 5.0s</p>	<p><b>7</b> Press T1   or T2   to display the dose of the hot water button. Pressing the button T3 , the dose value will blink. Use the button T1   or T2   to change the value, press the button T3  to confirm the desired value.</p>
<p>Long Water Dose 10.0s</p>	<p><b>8</b> Press T1   or T2   to display the long dose of the hot water button. Pressing the button T3 , the dose value will blink. Use the button T1   or T2   to change the value, press the button T3  to confirm the desired value.</p>

### Water Dose

### Description

Water Dose  
Settings

- This parameter allows the operator to program the amount of water (brewing amount) for the hot water button.
- This feature can be enabled or disabled.

Display	Operating Procedure
<p>Water Dose Exit</p>	<p><b>9</b> Press the T3 button   to return to the “Technical” programming.</p>
<p>Technician Menu Press B3 to Exit</p>	<p><b>10</b> Press T1   or T2   to continue with the programming of the other parameters.</p> <p><b>11</b> To exit the menu move between the parameters using the buttons T1   and T2   until the exit menu is displayed. Press the T3 button   to exit the menu and return to the normal use of the espresso machine.</p>
<p>LaMarzocco 00:00 CB 93.8°C SB</p>	<p><b>12</b> Alternatively, you can exit the “Technical” programming and return to the normal use of the espresso machine by pressing T2   and T3   at the same time.</p>

## “Technical” Programming

### Coffee Boiler



















#### Coffee Boiler Settings

#### Description

- This parameter enables the technician to set various parameters of the coffee boiler.
- The temperature of the boiler is measured at the most critical point in the boiler where temperature fluctuation is the greatest.
- The temperature of the water exiting the group head is held constant by means of the mass of the group casting. Even

though the temperature of the boiler may vary slightly, the temperature of the water exiting the group is constant.

- To properly calibrate the temperature of any espresso machine it is important to measure the temperature of the water exiting the group by means of an external temperature measuring device. The difference of the display temperature and the measured temperature may be compensated by use of the “Coffee T. Offset” parameter.

Display	Operating Procedure
Enter Password *****	<b>1</b> After accessing the “Technical” programming menu and entering the password, use the buttons T1   and T2  until the following screen is displayed.
Coffee Boiler Settings	<b>2</b> Press the T3 button   to enter the menu.
Coffee Boiler 1 ENABLED	<b>3</b> Press the T3 button   to enter the menu, move between the parameters using the buttons T1   and T2  to select ENABLED or DI SABLED , press the T3 button   to confirm the option. In the case of espresso machine with 4 groups you can set this option also on the coffee boiler 2.
CB1 Temperature 93.1°C    93.3°C	<b>4</b> Press the T3 button   to enter the menu, move with the buttons T1   and T2  to set the desired temperature, press the T3 button   to confirm the value. In the case of espresso machine with multiple boilers you can set the temperature also on the coffee boiler. The temperature indicated on the left is the actual temperature of the group while the temperature on the right is the set temperature.



### DANGER



THE STEAM BOILER CONTAINS WATER AT ELEVATED TEMPERATURES.  
WATER TEMPERATURE OVER 52°C CAN CAUSE SEVERE BURNS INSTANTLY OR DEATH FROM SCALDING.

## Coffee Boiler





























### Coffee Boiler Settings

### Description

- The OFFSET parameter is used to calibrate the coffee boiler temperature system to ensure the display temperature accurately represents the temperature of the water exiting the group head.
- This parameter is preset at the factory based upon initial tests of this espresso machine.
- It is not recommended that this number is changed. Changes to this parameter

can cause unexpected results.

- It is important to write down this value before making changes to be sure you can return to the factory programming if unexpected results occur. Each machine may have a different value as it is set individually.

Display	Operating Procedure
<div style="border: 1px solid black; padding: 5px; width: fit-content;">CB1 Offset 3.0°C</div>	<p><b>5</b> Press the T3 button   to enter the menu, move with the buttons T1   and T2   to set the desired temperature, press the T3 button   to confirm the value. In the case of espresso machine with 4 groups you can set this value also on the coffee boiler 2.</p>
<div style="border: 1px solid black; padding: 5px; width: fit-content;">CB1 RTD Trim 0</div>	<p><b>6</b> Press the T3 button   to enter the menu, move between the parameters with the buttons T1   and T2   to set the desired value, press the T3 button   to confirm the value.</p>
<div style="border: 1px solid black; padding: 5px; width: fit-content;">CB Settings Exit</div>	<p><b>7</b> Press the T3 button   to return to the “Technical” programming.</p> <p><b>8</b> Press T1   or T2   to continue with the programming of the other parameters.</p>
<div style="border: 1px solid black; padding: 5px; width: fit-content;">Technician Menu Press B3 to Exit</div>	<p><b>9</b> To exit the menu move between the parameters using the buttons T1   and T2   until the exit menu is displayed. Press the T3 button   to exit the menu and return to the normal use of the espresso machine.</p>



### DANGER



THE STEAM BOILER CONTAINS WATER AT ELEVATED TEMPERATURES.  
WATER TEMPERATURE OVER 52°C CAN CAUSE SEVERE BURNS INSTANTLY OR DEATH FROM SCALDING.

## “Technical” Programming

### Coffee Boiler





Coffee Boiler  
Settings

#### Description

- This parameter enables the technician to set various parameters of the coffee boiler.
- The temperature of the boiler is measured at the most critical point in the boiler where temperature fluctuation is the greatest.
- The temperature of the water exiting the group head is held constant by means of the mass of the group casting. Even

though the temperature of the boiler may vary slightly, the temperature of the water exiting the group is constant.

- To properly calibrate the temperature of any espresso machine it is import to measure the temperature of the water exiting the group by means of an external temperature measuring device. The difference of the display temperature and the measured temperature may be compensated by use of the “Coffee T. Offset” parameter.

Display	Operating Procedure
<p>LaMarzocco 00:00 CB 93.8°C SB</p>	<p>10 Alternatively, you can exit the “Technical” programming and return to the normal use of the espresso machine by pressing T2   and T3   at the same time.</p>



**DANGER**



THE STEAM BOILER CONTAINS WATER AT ELEVATED TEMPERATURES.  
WATER TEMPERATURE OVER 52°C CAN CAUSE SEVERE BURNS INSTANTLY OR DEATH FROM SCALDING.



## “Technical” Programming

### Steam Boiler

Steam Boiler  
Settings















#### Description

- This parameter enables the technician to set various parameters of the steam boiler.
- The temperature of saturated water is proportional to the pressure inside the Steam Boiler. Therefore it is possible to regulate the pressure of the steam boiler by means of electronic temperature control. Please use the following tables as reference when setting the steam boiler temperature.

Temperature	Pressure
247°F/119°C	1.0 bar
260°F/127°C	1.5 bar
264°F/129°C	2.0 bar

**CAUTION**

The saturation temperature of water will vary with ambient atmospheric pressure. Tables in this manual are created for atmospheric pressure at sea level. Slight adjustment in temperature will be required for elevations other than sea level.

Display	Operating Procedure
Enter Password *****	<ol style="list-style-type: none"> <li>1 After accessing the “Technical” programming menu and entering the password, use the buttons T1  and T2  until the following screen is displayed.</li> <li>2 Press the T3 button  to enter the menu.</li> <li>3 Press the T3 button  to enter the menu, move between the parameters using the buttons T1  and T2  to select ENABLED or DI SABLED , press the T3 button  to confirm the option.</li> <li>4 Press the T3 button  to enter the menu, move with the buttons T1  and T2  to set the desired temperature, press the T3 button  to confirm the value.</li> <li>5 Press the T3 button  to enter the menu, move between the parameters with the buttons T1  and T2  to set the desired value, press the T3 button  to confirm the value.</li> </ol>
Steam Boiler Settings	
Steam Boiler ENABLED	
Steam Temp. 123, 7°C 123, 5°C	
RTD Tri m 0	

**DANGER**

THE STEAM BOILER CONTAINS WATER AT ELEVATED TEMPERATURES.  
WATER TEMPERATURE OVER 52°C CAN CAUSE SEVERE BURNS INSTANTLY OR DEATH FROM SCALDING.









































## “Technical” Programming

### Steam Boiler

#### Steam Boiler Settings

#### Description

- The parameter filling WITH PUMP allows the technician to select the activation of the water pump during the automatic filling cycle of the service boiler.
- Only under unusual circumstances would the option of “WITHOUT PUMP” be chosen.
- The electronics installed in this espresso machine give priority to the brew boiler for pressure. The activation of the auto-fill cycle during the brewing process can reduce the overall dispensing pressure in the brew boiler.
- During the auto-fill cycle, if a brew cycle is chosen, the auto-fill cycle is delayed until all brew cycles are complete.
- The maximum permitted value for the temperature setting is 129°C.
- SAFETY TEST allows to bring the steam boiler temperature to 140°C, thus triggering the safety valve. Once the

Display	Operating Procedure
Autofill Delay 2 start 2 stop	<b>6</b> The first value indicates the time in seconds between the detection of the need to fill and the start of filling. The second value indicates the time in seconds between filling and its actual end. Press the T3 button   to enter the menu, move with the buttons T1   and T2   to set the desired automatic filling time, press the T3 button   to confirm the value.
Fill During Brew YES	<b>7</b> Press the T3 button   to enter the menu, move using the buttons T1   and T2   to select YES or NO, press the T3 button   to confirm the option.
Autofill Timeout 10 min	<b>8</b> Press the T3 button   to enter the menu, move with the buttons T1   and T2   to set the desired time, press the T3 button   to confirm the value.
Fill With Pump WI TH PUMP	<b>9</b> Press the T3 button   to enter the menu, move using the buttons T1   and T2   to select WI TH PUMP or WI THOUT PUMP, press the T3 button   to confirm the option.
Level Sensiti v. HI GH	<b>10</b> Press the T3 button   to enter the menu, move using the buttons T1   and T2   to select HI GH, LOW or MEDI UM, press the T3 button   to confirm the option.

**Steam Boiler**

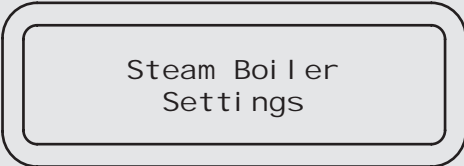

**Description**

- valve has triggered disable the function.
- Should the safety valve fail to trigger within approximately one minute of the temperature reaching 140°C, disable the function and replace the valve.
- Only qualified technicians can perform this operation.
- DRAIN STEAM BOILER allows the service staff to renew or “regenerate” the water contained inside the steam

boiler, discharging about one half of the water contained in the boiler.

- This procedure is recommended in case the machine should remain inactive for more than 8 hours and in any case at least on a weekly basis.

Display	Operating Procedure
Steam Boiler Safety Test	<p><b>11</b> Press the T3 button   to enable the function.</p>
SB 124.3/140.0°C Enter to Exit	<p><b>12</b> Press the T3 button   to exit the function.</p>
Drain Steam Boiler	<p>Press the T3 button   to enable the function.</p>
Close Water Valve Enter when Ready	<p>Manually close the mixing valve to allow the drain of the water contained in the steam boiler.</p>
Press Water Button Enter when Empty	<p>Press the hot water button to start draining the water contained in the steam boiler. Press the T3 button   when the boiler is empty, wait for refilling completion.</p>
Wait for Steam Boiler Autofill	

**⚠ DANGER ⚠**

**THE STEAM BOILER CONTAINS WATER AT ELEVATED TEMPERATURES.  
WATER TEMPERATURE OVER 52°C CAN CAUSE SEVERE BURNS INSTANTLY OR DEATH FROM SCALDING.**

























## “Technical” Programming

### Steam Boiler

### Description

Steam Boiler  
Settings

Display	Operating Procedure
Reset Water Valve Enter when Done	<b>13</b> Manually reopen the mixing valve and press the T3 button   . Now the procedure to renew or “regenerate” the water inside
Drain Steam Boiler Completed	
SB Settings Exit	<b>14</b> To exit the submenu move between the parameters using the buttons T1   and T2   until the exit submenu is displayed. Press the T3 button   to exit the submenu.
Technical Menu Press B3 to Exit	<b>15</b> Press T1   or T2   to continue with the programming of the other parameters.
	<b>16</b> To exit the menu move between the parameters using the buttons T1   and T2   until the exit menu is displayed. Press the T3 button   to exit the menu.
LaMarzocco 00:00 CB 93.8°C SB	<b>17</b> Alternatively, you can exit the “Technical” programming and return to the normal use of the espresso machine by pressing T2   and T3   at the same time.



### DANGER



























THE STEAM BOILER CONTAINS WATER AT ELEVATED TEMPERATURES.  
WATER TEMPERATURE OVER 52°C CAN CAUSE SEVERE BURNS INSTANTLY OR DEATH FROM SCALDING.

## Steam Boiler

### Description

Steam Boiler  
Settings

- The parameter “Level Sensit.” allows the technician to select the probe sensitivity for steam boiler filling according to water hardness.
- The probe level installed corresponds to the working level.
- The sensitivity default value is high.

Display	Operating Procedure
Enter Password *****	<b>1</b> After accessing the “Technical” programming menu and entering the password, use the buttons T1   and T2   until the following screen is displayed.
Steam Boiler Settings	<b>2</b> Press the T3   button to enter the menu, navigate the parameters using the buttons T1   and T2   until the following screen is displayed:
Level Sensitiv. HIGH	<b>3</b> Press the T3 button   to enter the menu, move using the buttons T1   and T2   to select HIGH, MID or LOW, press the T3 button   to confirm the option.
SB Settings Exit	<b>4</b> To exit the submenu move between the parameters using the buttons T1   and T2   until the exit submenu is displayed. Press the T3 button   to exit the submenu.



### DANGER



THE STEAM BOILER CONTAINS WATER AT ELEVATED TEMPERATURES.  
WATER TEMPERATURE OVER 52°C CAN CAUSE SEVERE BURNS INSTANTLY OR DEATH FROM SCALDING.





## “Technical” Programming (only on espresso machine models WITH sight glass)

### Steam Boiler

Steam Boiler  
Settings

### Description

- The parameter “Level Sensit.” allows the technician to select the probe sensitivity for steam boiler filling according to water hardness.
- The probe level installed corresponds to the working level.
- The sensitivity default value is high.

















Display	Operating Procedure
Technician Menu Press B3 to Exit	<b>5</b> To exit the menu move between the parameters using the buttons T1  ◀ and T2  ▶ until the exit menu is displayed. Press the T3 button   to exit the menu.
Restart Machine for Changes	
	<b>6</b> Turn the Main Switch to the 0 position.
LaMarzocco 00:00 CB 93.8°C SB	<b>7</b> Now it is possible to turn on again the espresso machine; set the main switch to position 1 and press any button to complete machine switch on.

## Steam Boiler

### Description

Steam Boiler  
Settings

- The parameter “Level Sensit.” allows the technician to select the probe sensitivity for steam boiler filling according to water hardness.
- The black connection cable corresponds to the working level probe.
- The red connection cable corresponds to the minimum level probe.
- The sensitivity default value is high.

Display	Operating Procedure
Enter Password *****	<b>1</b> After accessing the “Technical” programming menu and entering the password, use the buttons T1   and T2  until the following screen is displayed.
Steam Boiler Settings	<b>2</b> Press the T3  button to enter the menu, navigate the parameters using the buttons T1   and T2  until the following screen is displayed:
Level Sensitiv. HIGH	<b>3</b> Press the T3 button  to enter the menu, move using the buttons T1   and T2  to select HIGH, MID or LOW, press the T3 button  to confirm the option.
SB Settings Exit	<b>4</b> To exit the submenu move between the parameters using the buttons T1   and T2  until the exit submenu is displayed. Press the T3 button  to exit the submenu.



### DANGER



THE STEAM BOILER CONTAINS WATER AT ELEVATED TEMPERATURES.  
WATER TEMPERATURE OVER 52°C CAN CAUSE SEVERE BURNS INSTANTLY OR DEATH FROM SCALDING.





## “Technical” Programming (only on espresso machine models WITHOUT sight glass)

### Steam Boiler

Steam Boiler  
Settings

### Description

- The parameter “Level Sensit.” allows the technician to select the probe sensitivity for steam boiler filling according to water hardness.
- The black connection cable corresponds to the working level probe.
- The red connection cable corresponds to the minimum level probe.
- The sensitivity default value is high.

Display	Operating Procedure
Technici an Menu Press B3 to Exit	<b>5</b> To exit the menu move between the parameters using the buttons T1  ◀ and T2  ▶ until the exit menu is displayed. Press the T3 button   to exit the menu.
Restart Machi ne for Changes	
	<b>6</b> Turn the Main Switch to the 0 position.
LaMarzocco 00: 00 CB 93. 8°C SB	<b>7</b> Now it is possible to turn on again the espresso machine; set the main switch to position 1 and press any button to complete machine switch on.



### Pre-Infusion or Pre-Brewing



































Pre-Inf  
Settings

### Description

- This parameter allows the operator to program the time of pre-brewing of water with the coffee. Each group can have a different programming.
- Pre-brewing has only two values to be adjusted for each group. The time (in seconds) for which the brewing valve is open during the pre-brewing cycle and the time (in seconds) for which the brewing valve is closed during the

pre-brewing cycle; during this time the pump is active. Once the pre-brewing cycle is over, the normal brewing cycle will continue until the end.

- For an espresso machine composed of three groups, they are identified as Group 1, Group 2 and Group 3.

Display	Operating Procedure
LaMarzocco 00:00 CB 93.8°C SB	<b>1</b> When the espresso machine is turned on, press and hold the T3 button   to access the “Barista” programming. After about 5 seconds the following screen is displayed.
Program Dose	<b>2</b> Move between the parameters using the buttons T1   and T2   until the display shows:
Pre-Inf Settings	<b>3</b> Press the T3 button   to enter the menu.
Group 1 Pre-Inf Os Wet Os Hold	<b>4</b> Press T1   or T2   to select the group whose parameters you want to set. By pressing the T3 button   the first value will blink. Use the buttons T1   and T2   to reach the value that you want to set, press T3   to confirm. Repeat this operation to set the second value.
Pre-Inf Settings Exit	<b>5</b> To exit the menu move between the parameters using the buttons T1   and T2   until the exit menu is displayed. Press the T3 button   to exit the menu.
	<b>6</b> Press T1   or T2   to continue with the programming of the other parameters.
LaMarzocco 00:00 CB 93.8°C SB	<b>7</b> Press T2   and T3   at the same time to exit the programming mode and return to the normal use of the espresso machine.

## “Technical” Programming

### Crono Function

Di spl ay Chrono  
NO

### Description

- When enabled, this parameter displays a timer that times each shot.
- The timer is reset each time a button on the keypad is pressed.
- If enabled, the Chrono function is permanently displayed during brewing, while during wait state it alternates with the programmable name.





















Display	Operating Procedure
Enter Password *****	<b>1</b> After accessing the “Technical” programming menu and entering the password, use the buttons T1   and T2   until the following screen is displayed.
Di spl ay Chrono NO	<b>2</b> Press the T3 button  to enter the menu, move between the parameters using the buttons T1   and T2   to select an option (NO/TI ME/DOSE), press the T3 button  to confirm the option.
GR1 GR2 GR3 18 0 0	<b>3</b> In the case of active option (TI ME or DOSE ) the display shown to the side appears.
	<b>4</b> Press T1   or T2   to continue with the programming of the other parameters.
Techni ci an Menu Press B3 to Exit	<b>5</b> To exit the menu move between the parameters using the buttons T1   and T2   until the exit menu is displayed. Press the T3 button  to exit the menu.
LaMarzocco 00:00 CB 93.8°C SB	<b>6</b> Alternatively, you can exit the “Technical” programming and return to the normal use of the espresso machine by pressing T2   and T3  at the same time.

## Clock Adjust

Clock Time  
00: 00 MONDAY

### Description

- This parameter allows the user to set the time of day and the day of the week.
- This parameter is used to display time and is also used by the “Auto On/Off” parameter
- There are 4 changeable values within this parameter:
  - Hour;
  - Minute;
  - Day of week;
  - Hour Format 12h or 24h.

Display	Operating Procedure
Enter Password *****	<b>1</b> After accessing the “Technical” programming menu and entering the password, use the buttons T1   and T2   until the following screen is displayed.
Clock Time 00: 00 MONDAY	<b>2</b> Pressing the T3 button  the first value will blink. Use the buttons T1   and T2   to set the clock. Repeat the operation to set the day of the week.
	<b>3</b> Press T1   or T2   to continue with the programming of the other parameters.
Technical Menu Press B3 to Exit	<b>4</b> To exit the menu move between the parameters using the buttons T1   and T2   until the exit menu is displayed. Press the T3 button  to exit the menu.
LaMarzocco 00:00 CB 93.8°C SB	<b>5</b> Alternatively, you can exit the “Technical” programming and return to the normal use of the espresso machine by pressing T2   and T3  at the same time.







































## “Technical” Programming

### Cup Warmer

Cup Warmer  
Settings

### Description

- This parameter allows the technician to enable or disable the cups heating function.
- This parameter allows the technician to adjust the operating time of the resistance for the heating of the cups.
- This parameter allows the technician to select the operating of the cup warmer by time or by button on the control panel.
- This function is displayed only on the models of espresso machine equipped with this accessory.











Display	Operating Procedure
Enter Password *****	<b>1</b> After accessing the “Technical” programming menu and entering the password, use the buttons T1   and T2   until the following screen is displayed.
Cup Warmer Settings	<b>2</b> Press the T3 button   to enter the menu.
Cup Warmer ENABLED	<b>3</b> Press the T3 button   to enter the menu, move between the parameters using the buttons T1   and T2   to select ENABLED or DI SABLED, press the T3 button   to confirm the option.
Cup Warmer TIME	<b>4</b> Press the T3 button   to enter the menu, move between the parameters using the buttons T1   and T2   to select TI ME or BY BUTTON, press the T3 button   to confirm the option.
Cup Warmer T On 2mi n	<b>5</b> Press the T3 button   to enter the menu, move between the parameters with the buttons T1   and T2   to set the desired time, press the T3 button   to confirm the value.
Cup Warmer T Off 8mi n	<b>6</b> Press the T3 button   to enter the menu, move between the parameters with the buttons T1   and T2   to set the desired time, press the T3 button   to confirm the value.

### Cup Warmer

Cup Warmer  
Settings

### Description

- This parameter allows the technician to enable or disable the cups heating function.
- This parameter allows the technician to adjust the operating time of the resistance for the heating of the cups.
- This parameter allows the technician to select the operating of the cup warmer by time or by button on the control panel.
- This function is displayed only on the models of espresso machine equipped with this accessory.

Display	Operating Procedure
<div style="border: 1px solid black; padding: 5px; margin-bottom: 10px;">Cup Warmer Exit</div>	<p><b>7</b> To exit the submenu move between the parameters using the buttons T1  and T2  until the exit submenu is displayed. Press the T3 button  to exit the submenu.</p> <p><b>8</b> Press T1  or T2  to continue with the programming of the other parameters.</p>
<div style="border: 1px solid black; padding: 5px; margin-bottom: 10px;">Technician Menu Press B3 to Exit</div>	<p><b>9</b> To exit the menu move between the parameters using the buttons T1  and T2  until the exit menu is displayed. Press the T3 button  to exit the menu.</p>
<div style="border: 1px solid black; padding: 5px;">LaMarzocco 00:00 CB 93.8°C SB</div>	<p><b>10</b> Alternatively, you can exit the “Technical” programming and return to the normal use of the espresso machine by pressing T2  and T3  at the same time.</p>

## “Technical” Programming

### Auto ON/OFF

Auto On/Off  
Settings

### Description

- This parameter allows the technician to program the espresso machine to turn on at a preset time and turn off at a preset time.
- This feature also allows the espresso machine to remain in the off condition for one repeating closed day.











Display	Operating Procedure
Enter Password *****	<b>1</b> After accessing the “Technical” programming menu and entering the password, use the buttons T1   and T2   until the following screen is displayed.
Auto On/Off Settings	<b>2</b> Press the T3 button  to enter the menu.
Auto On/Off ENABLED	<b>3</b> Press the T3 button  to enter the menu, move between the parameters using the buttons T1   and T2   to select ENABLED or DI SABLED , press the T3 button  to confirm the option.
Auto On Time 00:00	<b>4</b> If the parameter is enabled, press the T3 button  to enter the menu, move with the buttons T1   and T2   to set the desired time, press the T3 button  to confirm the value.
Auto Off Time 00:00	<b>5</b> Press the T3 button  to enter the menu, move with the buttons T1   and T2   to set the desired time, press the T3 button  to confirm the value.
Closed On NEVER	<b>6</b> Press the T3 button  to enter the menu, move with the buttons T1   and T2   to select an option, press the T3 button  to confirm the option.

### Auto ON/OFF

Auto On/Off  
Settings

### Description

- This parameter allows the technician to program the espresso machine to turn on at a preset time and turn off at a preset time.
- This feature also allows the espresso machine to remain in the off condition for one repeating closed day.

Display	Operating Procedure
Auto On/Off Exit	<p><b>7</b> To exit the submenu move between the parameters using the buttons T1  ◀ and T2  ▶ until the exit submenu is displayed. Press the T3 button  to exit the submenu.</p>
Technician Menu Press B3 to Exit	<p><b>8</b> Press T1  ◀ or T2  ▶ to continue with the programming of the other parameters.</p>
LaMarzocco 00:00 CB 93.8°C SB	<p><b>9</b> To exit the menu move between the parameters using the buttons T1  ◀ and T2  ▶ until the exit menu is displayed. Press the T3 button  to exit the menu.</p> <p><b>10</b> Alternatively, you can exit the “Technical” programming and return to the normal use of the espresso machine by pressing T2  ▶ and T3  at the same time.</p>































## “Technical” Programming

### ECO Mode

Eco Mode  
Settings

### Description

- This parameter allows the technician to set up a temperature to be maintained in case of a temporary non utilization of the espresso machine.
- It is possible to set this parameter also during the normal operation of the machine by pressing T1 and T2 at the same time.

Display	Operating Procedure
Enter Password *****	<b>1</b> After accessing the “Technical” programming menu and entering the password, use the buttons T1   and T2   until the following screen is displayed.
Eco Mode Settings	<b>2</b> Press the T3 button   to enter the menu.
Eco Mode Temp -10.0°C	<b>3</b> Press the T3 button   to enter the menu, move between the parameters with the buttons T1   and T2   to set the desired temperature, press the T3 button   to confirm the value.
Auto Eco Time 30	<b>4</b> Press the T3 button   to enter the menu, move between the parameters with the buttons T1   and T2   to set the desired time (in minutes), press the T3 button   to confirm the value. A value of “0” (zero) disables the Eco Mode parameter.
Btn Shortcut B1+B2	<b>5</b> Press the T3 button   to enter the menu, move between the parameters using the buttons T1   and T2   to select B1+B2 or DISABLED, press the T3 button   to confirm the option.



### ECO Mode

### Description

Eco Mode  
Settings

- This parameter allows the technician to set up a temperature to be maintained in case of a temporary non utilization of the espresso machine.
- It is possible to set this parameter also during the normal operation of the machine by pressing T1 and T2 at the same time.

Display	Operating Procedure
Eco Mode Exit	<p><b>6</b> To exit the submenu move between the parameters using the buttons T1  and T2  until the exit submenu is displayed. Press the T3 button  to exit the submenu.</p> <p><b>7</b> Press T1  or T2  to continue with the programming of the other parameters.</p>
Technician Menu Press B3 to Exit	<p><b>8</b> To exit the menu move between the parameters using the buttons T1  and T2  until the exit menu is displayed. Press the T3 button  to exit the menu.</p>
LaMarzocco 00:00 CB 93.8°C SB	<p><b>9</b> Alternatively, you can exit the “Technical” programming and return to the normal use of the espresso machine by pressing T2  and T3  at the same time.</p>













## “Technical” Programming (only on AV and ABR espresso machine models)

### Coffee Dose Counter

Coffee Dose Counter

#### Description

- This parameter allows the technician to review the total doses dispensed for each button.
- This parameter displays different values:
  - Total coffee doses;
  - Coffee doses for each button;
  - Hot water doses.











Display	Operating Procedure
Enter Password *****	<b>1</b> After accessing the “Technical” programming menu and entering the password, use the buttons T1  and T2  until the following screen is displayed.
Coffee Dose Counter	<b>2</b> Press the T3 button  to enter the menu.
Total Coffee Doses: 63	<b>3</b> Move between the parameters using the buttons T1  and T2  to display the desired option:
Doses G1B1 10	<b>4</b> Continuing to move with the buttons T1  and T2  you can display the total doses of each button.
Doses G1B2 3	<b>5</b> Continuing to move with the buttons T1  and T2  you can display the total doses of each button.
Doses G1B3 5	<b>6</b> Continuing to move with the buttons T1  and T2  you can display the total doses of each button.
Water Doses 30	<b>7</b> Continuing to move with the buttons T1  and T2  you can also display the total doses of the hot water button.

## Coffee Dose Counter

Coffee Dose Counter

### Description

- This parameter allows the technician to review the total doses dispensed for each button.
- This parameter displays different values:
  - Total coffee doses;
  - Coffee doses for each button;
  - Hot water doses.

Display	Operating Procedure
<p>Coffee Doses Exit</p>	<p><b>8</b> To exit the submenu move between the parameters using the buttons T1  and T2  until the exit submenu is displayed. Press the T3 button  to exit the submenu.</p> <p><b>9</b> Press T1  or T2  to continue with the programming of the other parameters.</p>
<p>Technical Menu Press B3 to Exit</p>	<p><b>10</b> To exit the menu move between the parameters using the buttons T1  and T2  until the exit menu is displayed. Press the T3 button  to exit the menu.</p>
<p>LaMarzocco 00:00 CB 93.8°C SB</p>	<p><b>11</b> Alternatively, you can exit the “Technical” programming and return to the normal use of the espresso machine by pressing T2  and T3  at the same time.</p>

## “Technical” Programming (only on MP espresso machine models)

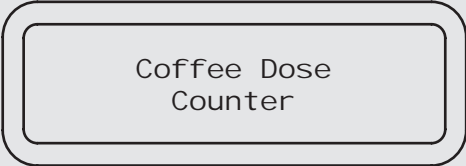

### Coffee Dose Counter

#### Description

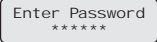
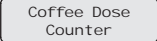
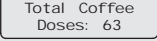

Coffee Dose  
Counter

- This parameter allows the technician to review the total doses.
- This parameter displays different values:
  - Total coffee doses;
  - Coffee doses for each group;
  - Hot water doses.

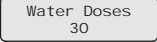
Display	Operating Procedure
	<b>1</b> After accessing the “Technical” programming menu and entering the password, use the buttons T1 (◀) and T2 (▶) until the following screen is displayed.
	<b>2</b> Press the T3 button (OK) to enter the menu.
	<b>3</b> Move between the parameters using the buttons T1 (◀) and T2 (▶) to display the desired option:
	<b>4</b> Continuing to move with the buttons T1 (◀) and T2 (▶) you can display the total doses of each group.
	<b>5</b> Continuing to move with the buttons T1 (◀) and T2 (▶) you can also display the total doses of the hot water button.

## Coffee Dose Counter

### Description

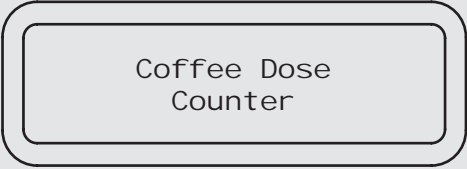

Coffee Dose  
Counter

- This parameter allows the technician to review the total doses.
- This parameter displays different values:
  - Total coffee doses;
  - Coffee doses for each group;
  - Hot water doses.

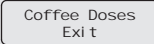
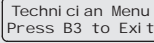
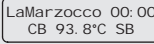
Display	Operating Procedure
	<b>6</b> To exit the submenu move between the parameters using the buttons T1 (◀) and T2 (▶) until the exit submenu is displayed. Press the T3 button (OK) to exit the submenu.
	<b>7</b> Press T1 (◀) or T2 (▶) to continue with the programming of the other parameters.
	<b>8</b> To exit the menu move between the parameters using the buttons T1 (◀) and T2 (▶) until the exit menu is displayed. Press the T3 button (OK) to exit the menu.
	<b>9</b> Alternatively, you can exit the “Technical” programming and return to the normal use of the espresso machine by pressing T2 (▶) and T3 (OK) at the same time.

























## “Technical” Programming

### Filter Alarm

Filter Alarm  
Settings

### Description

- This parameter enables the technician to program an alarm that will alert the user about the need for maintenance or replacement of the water filter.
- Once the set volume has been reached, the error message “Filter Alarm” will be displayed.
- A value of 0 (zero) disables the filter alarm parameter.
- This feature can be enabled or disabled.





























Display	Operating Procedure
Enter Password *****	<b>1</b> After accessing the “Technical” programming menu and entering the password, use the buttons T1   and T2  until the following screen is displayed.
Filter Alarm Settings	<b>2</b> Press the T3 button   to enter the menu, move between the parameters using the buttons T1   and T2  to select ENABLED or DISABLED, press the T3 button   to confirm the option.
Filter Alarm ENABLED	
Alarm Units LITERS / DAYS	<b>3</b> Press the T3 button   to enter the menu, move between the parameters using the buttons T1   and T2  to select LITERS or DAYS, press the T3 button   to confirm the option.
Filter Status 0 of 1000L	
Filter Alarm 1000 Liters	<b>5</b> Press the T3 button   to enter the menu, move between the parameters with the buttons T1   and T2  to set the desired value, press the T3 button   to confirm the value.

### Filter Alarm

Filter Alarm  
Settings

### Description

- This parameter allows the technician to preprogram an alarm that notifies the user when the water filter requires service or replacement.
- When the programmed volume of water has passed through the espresso machine the error message “Change Filter” is displayed.
- A value of 0 (zero) disables the filter alarm parameter.
- This feature can be enabled or disabled.

Display	Operating Procedure
Alarm Water Use 40 Coffee Water	<b>6</b> Press the T3 button   to enter the menu, move between the parameters with the buttons T1   and T2   to set the desired value, press the T3 button   to confirm the value.
Filter Alarm Exit	<b>7</b> To exit the submenu move between the parameters using the buttons T1   and T2   until the exit submenu is displayed. Press the T3 button   to exit the submenu.
Technician Menu Press B3 to Exit	<b>8</b> Press T1   or T2   to continue with the programming of the other parameters.
LaMarzocco 00:00 CB 93.8°C SB	<b>9</b> To exit the menu move between the parameters using the buttons T1   and T2   until the exit menu is displayed. Press the T3 button   to exit the menu.
	<b>10</b> Alternatively, you can exit the “Technical” programming and return to the normal use of the espresso machine by pressing T2   and T3   at the same time.



















## “Technical” Programming

### Reset

Reset  
Settings

### Description

- This parameter allows the technician to reset all the values returning to initial factory settings.
- It is possible to reset the settings you made in the “Barista” programming or the settings you made in the “Technical” programming.

Display	Operating Procedure
Enter Password *****	<b>1</b> After accessing the “Technical” programming menu and entering the password, use the buttons T1   and T2   until the following screen is displayed.
Reset Settings	<b>2</b> Press the T3 button   to enter the menu.
Barista Settings Reset	<b>3</b> Press the T3 button   to reset the settings you made in the “Barista” programming.
Tech. Settings Reset	<b>4</b> Press the T3 button   to reset the settings you made in the “Technical” programming.
RTD Trim Reset	<b>5</b> Press the T3 button   to reset the RTD Trim.
Reset Exit	<b>6</b> To exit the submenu move between the parameters using the buttons T1   and T2   until the exit submenu is displayed. Press the T3 button   to exit the submenu.

















### Reset

Reset  
Settings

### Description

- This parameter allows the technician to reset all the values returning to initial factory settings.
- It is possible to reset the settings you made in the “Barista” programming or the settings you made in the “Technical” programming.

Display	Operating Procedure
<div data-bbox="161 657 315 699" style="border: 1px solid black; padding: 2px;">                     Technician Menu Press B3 to Exit                 </div>	<p><b>7</b> Press T1   or T2   to continue with the programming of the other parameters.</p> <p><b>8</b> To exit the menu move between the parameters using the buttons T1   and T2   until the exit menu is displayed. Press the T3 button   to exit the menu. Alternatively, you can exit the “Technical” programming and return to the normal use of the espresso machine by pressing T2   and T3   at the same time.</p>







## “Technical” Programming

### Update Firmware

Update Firmware

### Description

- This parameter allows the technician to update the control unit of the espresso machine via a USB Pendrive.



Display	Operating Procedure
<p>Enter Password *****</p>	<p><b>1</b> After accessing the “Technical” programming menu and entering the password, use the buttons T1   and T2  until the following screen is displayed.</p>
<p>Update Firmware</p>	<p><b>2</b> Press the T3 button   to update the firmware. The following screen will immediately appear.</p>
<p>Insert USB Key And Press Enter</p>	<p><b>3</b> Insert the USB Pendrive into the USB port and press the T3 button  .</p>
<p>OFF 00:00</p>	<p><b>4</b> When the update is over, the espresso machine restarts. Set the switch to 0 (zero) and then again to 1.</p>

## Exit Menu

### Description

Technician Menu  
Press B3 to Exit

- This parameter allows the technician to exit the “Technical” programming and return to the normal use of the espresso machine.

Display	Operating Procedure
<p>Technician Menu Press B3 to Exit</p>	<p>1 Press the T3 button   to exit the “Technical” programming and return to the normal use of the espresso machine.</p>

## Troubleshooting

- This espresso machine is equipped with several feedback mechanisms that alert the operator when an unusual condition occurs. Additionally the espresso machine will warn the operator when certain parameters fall below or above the programmed point. These errors and warnings will appear as a message in the display.
- The following section will describe errors and warnings that may appear in the display.

Message	Description	Message Solution
Steam Boiler AutoFill Failed	This message is displayed when the CPU does not detect a full signal from the steam boiler within the set time interval.	When this message is displayed the CPU also shuts down and turns off power to the machine (see the parameter "Level Timeout"). Press the ON/OFF button to reset this error.
Coffee Boiler 1 Probe Failed	This message is displayed when the CPU does not detect the temperature probe.	When this message is displayed the CPU shuts down and turns off the machine. The way to reset this error is to verify and to reconnect the temperature probe.
SB Filled?	This message is displayed during first installation and when preset of settings is made.	Push enter if Steam Boiler is filled. Verify the presence of water looking the sight glass.
Groups Bled?	This message is displayed during first installation and when preset of settings is made.	Push enter if groups have been blend ie no air is present in groups.
Coffee Boiler 1 Is Not Heating	This message is displayed when the coffee boiler does not reach the minimum temperature with the programmed time interval.	See the parameter "Heating Timeout" for more information. The number on the display corresponds to the number of the faulty coffee boiler.
Coffee Boiler 1 Overheated	This message is displayed when the coffee boiler temperature exceeds the maximum allowed temperature.	When this message is displayed call an authorized service technician to repair this fault. The also CPU turns power off to the coffee boiler.
Steam Boiler Probe Failed	This message is displayed when the CPU does not detect the temperature probe.	When this message is displayed the CPU shuts down and turns off the machine. The way to reset this error is to verify and to reconnect the temperature probe.
Steam Boiler Overheated	This message is displayed when the steam boiler temperature exceeds the maximum allowed temperature.	When this message is displayed call an authorized service technician to repair this fault. The also CPU turns power off to the steam boiler.
Steam Boiler Is Not Heating	This message is displayed when the steam boiler does not reach the minimum temperature with the programmed time interval.	See the parameter "Heating Timeout" for more information.

Message	Description	Message Solution
Flow Meter 1 No Pulse	This message is displayed when the CPU does not receive the appropriate signal from the flowmeter.	When the flowmeter alarm is displayed, push a button to turn off the alarm. This problem is a result of water not flowing through the flow meter. This can be caused by the coffee packed too tightly, a blockage in the tubes, a malfunctioning water pump, a faulty valve, or a damaged flowmeter. Call a service technician to fix this problem.
Autofill In Progress	This message is displayed when the steam boiler autofill cycle is activated and water is entering the steam boiler.	No action is required when this message is displayed. This message is only displayed to notify the operator of the active process.
Invalid Password	This message is displayed when password entered does not match the programmed password.	This error message will be displayed anytime an incorrect password is entered. The machine comes back to the previous state.
Provide for the replacement	This message is displayed when the filter alarm is on. All the buttons flash	When this message is displayed perform the required maintenance operations on the water filter or replace it. No action is required on the espresso machine.

