

manual

gb5

Named for Giovanna Bambi and designed with classic La Marzocco styling and spirit, the GB/5 combines harmonious aesthetics and powerful technological advancements. With gracious lines and curves. The GB/5 is an understated companion to any coffee bar, while its unmatched temperature stability provides steady brew water and steam even at the peak of the morning rush.

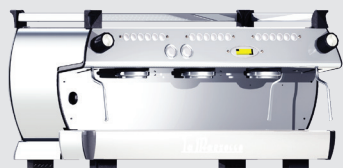

la marzocco

handmade in florence

gb5

Operating Manual V3.0 - 01/2020
MAN.3.1.02

Chapters

1. General Warnings and Safety Specifications	page 3
2. Definition of Available Models	page 7
3. Installation	page 9
4. Machine Operation and Coffee Preparation	page 15
5. Dispensing Steam and Hot Water	page 18
6. Maintenance and Periodic Cleaning Operations	page 19
7. De-commissioning and Demolition	page 22
8. Mandatory Maintenance and Check-up Operations	page 23
9. Software Programming Guide	page 24



la marzocco

handmade in florence

La Marzocco S.r.l.

Via La Torre 14/H
Località La Torre
50038 Scarperia e San Piero
(Firenze) - ITALIA

www.lamarzocco.com
info@lamarzocco.com

T: +39 055 849 191
F: +39 055 849 1990

Original instructions verified by the
manufacturer.



Scan QR Code to view the complete
Software Programming Guide available on
the techcenter website.

Printed on recycled paper.

certifications available:



1. General Warnings and Safety Specifications

▲ WARNING ▲

This machine is for professional use only and should be installed in locations where its use and maintenance is restricted to trained personnel. Children are forbidden to operate or play with the machine.

▲ WARNING ▲

The Coffee machine must be placed in a horizontal position on a counter higher than 80 cm from the ground.

▲ WARNING ▲

This machine is not suitable for outdoor use. Jets of water should not be used to clean the machine, nor should it be placed where water jets are used.

▲ CAUTION ▲

As already mentioned in the preceding notes, the manufacturer shall not be held responsible for damage to objects, animals and/or people whenever the machine has not been installed according to the instructions contained in this manual, and is not used to do what it was designed for (i.e. preparing coffee and hot drinks).

1) Important safeguards

- The weighted sound pressure level of the machine is lower than 70dBA.
- Use, cleaning and maintenance of this coffee machine are realized by people (including children more than 8

years of age) with reduced physical, sensory or mental capabilities, or lack of experience and knowledge, as long as they have been given supervision or instructions concerning the use of the appliance by a person responsible for their safety and if they understand dangers.

- Children should be supervised to ensure that they do not play with the appliance.
 - Keep the appliance and its cord out of the reach of children less than 8 years of age.
- 2) This operating manual is an integral and essential part of the product and must be supplied to users.

Users are asked to read the enclosed warnings and cautions carefully, as they provide valuable information concerning safety during installation, operation and maintenance. This manual must be kept in a safe place and be available for consultation to new and experienced users alike.

3) Ensure product's integrity by inspecting the packaging, making sure it presents no signs of damage which might have affected the enclosed machine.

4) Check the machine's integrity after having carefully removed the packaging.

Note: In case of doubt, do not go on any further and contact your dealer or retailer immediately. They

will send out specialized personnel authorized to perform service on the espresso machine.

5) Packaging (boxes, plastic bags, foam parts and whatever else) must not be left around within easy reach of children, due to the potential danger it represents, nor be discarded in the environment.

6) Check to see that data on the rating plate corresponds to those of the main electrical supply which the machine will be hooked up to.

7) The equipment must be installed to comply with the applicable federal, state or local electrical and plumbing codes. The installation also must comply to the manufacturer's instructions, and must be performed by

qualified and authorized personnel.

8) Incorrect installation may cause for injury/damages to people, animals or objects, for which the manufacturer shall not be held responsible.

9) Safe electrical operation of this device will be achieved only when the connection to the power outlet has been completed correctly and in observance of all local, national, and international electrical codes and safety regulations, and particularly by grounding the unit. Make sure grounding has been done properly as it represents a fundamental safety requirement. Ensure qualified personnel check such connection.

10) Furthermore, you must ensure that the capacity of the available electrical system is suitable for the maximum power consumption indicated on the espresso machine.

11) We do not recommend using adapters, multiple plugs and/or extension cords. If you cannot avoid using them, make sure that they are exclusively of the kind which conforms to local, national, and international electrical codes and safety regulations, being careful not to exceed the power and current ratings indicated on such adapters and extension cords.

12) This device must be used exclusively for the functions it has been designed and built for. Any other application is

inappropriate and dangerous.
The manufacturer shall not be held responsible for any damages caused by improper and/or irrational use.

This machine should not be installed in kitchens.

13) Using any electrical device requires that certain fundamental rules be observed. In particular:

- do not touch the device with wet or humid hands and feet;
- do not use the device while having no shoes on your feet;
- do not use extension cords in bath or shower rooms;
- do not unplug the device from the power outlet by pulling on the power supply cable;
- do not expose the device to

atmospheric agents (rain, sun, etc.);

- do not allow children or untrained people to use this device;
- do not clean the control panel with a wet cloth since it is not watertight.

14) Before carrying out any maintenance and/or cleaning operations, turn the main switch, which is located on the front left of the machine, to the “0” or “OFF” position, and disconnect the machine from the electrical network by unplugging the cord or by switching off the relative circuit breaker. For any cleaning operation, follow exclusively the instructions contained in this manual.

15) In case the machine is

operating in a faulty manner or breaks down, disconnect it from the electrical network (as described in the preceding point) and close the water supply valve. Do not attempt to repair it. Contact a qualified and authorized professional to perform any repair. Any repairs must be performed exclusively by the manufacturer or by an authorized centre using only original parts. Non compliance with the above could compromise the safe operation of the machine.

16) You should plan to make use of an omnipolar connector during installation, as required by local, national, and international electrical codes and regulations.

17) In order to avoid dangerous

overheating problems, it is recommended that the power supply cable be fully unfurled.

18) Do not obstruct air intake and exhaust grilles and, in particular, do not cover the cup warmer tray with cloths or other items.

19) The machine's power supply cable must not be replaced by users. In case the power supply cable becomes damaged, shut off the machine and disconnect the machine from the electrical network by switching off the relative circuit breaker and close off the water supply; to replace the power supply cord, contact qualified professionals exclusively.

20) These instructions are also available in an alternative

format on a website <http://techcenter.lamarzocco.com>.

21) COMMON DIMENSIONS, WEIGHTS, AND FEATURES

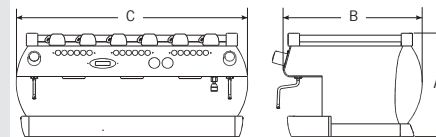

GB5	2 groups	3 groups	4 groups
A [mm]	475	475	475
B [mm]	622	622	622
C [mm]	750	950	1190
WEIGHT [kg]	63	77	107

2. Definition of Available Models

This operating manual refers exclusively to the following models, of our own manufacture:

GB/5, Model EE & AV and MP into 2, 3 and 4 groups

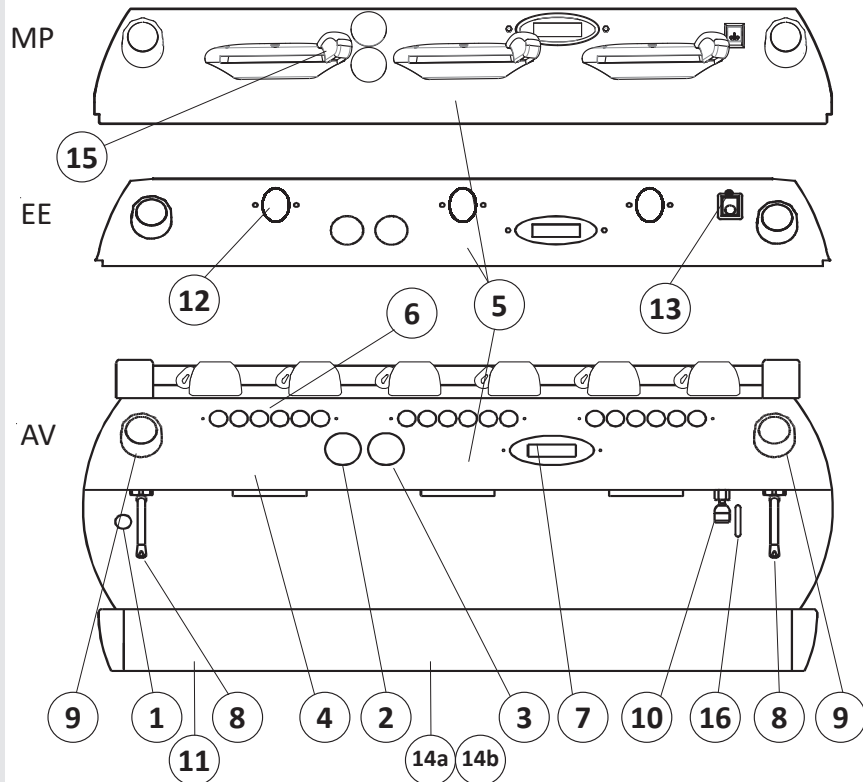

Legend

- 1** Main Switch
- 2** Pressure Gauge (Steam Boiler)
- 3** Pressure Gauge (Coffee Boiler)
- 4** Brew Groups
- 5** Control Panel
- 6** Group #1 Keypad
- 7** Digital Display
- 8** Steam Wand
- 9** Steam Knob
- 10** Hot Water dispense nozzle
- 11** Removable Drain Tray
- 12** Manual Brew Switch (EE model)
- 13** Hot Water Switch (EE model)
- 14a** Electronic Board EE & AV
- 14b** Electronic Board MP + Programming Keypad
- 15** Paddle Knob
- 16** Hot Water Mix Valve

For additional information on electronics, keypads, and software programming, please see the section entitled Software Programming your Espresso Machine.

Fig. 1 - Model AV & EE with 2, 3, or 4 groups

1) General description

The machine is built in 2, 3, and 4 group versions and is essentially composed of the following parts:

- Steam Boiler (produces steam and hot water)
- Coffee (“saturation”) boiler
- Brewing groups
- Exterior Cover
- Water pump

2) Description of the various parts

• Steam Boiler

The Steam Boiler consists of a cylindrical tank, of varying length according to the number of coffee groups, which is made of AISI 300 series stainless steel. Each unit is subjected to a bench test, at a pressure of 6 bar, and has an operating pressure of 1.3-1.5 bar. The following is a list of effective volumes and power ratings according to the number of groups installed:

2 groups	7.0 liters	2000 or 3000 Watts
3 groups	11 liters	3000 or 4000 Watts
4 groups	15 liters	3800 or 5000 Watts

Covers are installed at either end of the cylindrical tank and on one of them there is a housing for the water-heating element, which allows the steam boiler to reach

operating pressure within approximately 25 minutes. Operating pressure is maintained by a pressure switch or a temperature probe. The steam boiler has various fittings used for safety devices, hot water, steam, and for the heating element.

• Coffee boiler

The Coffee Boiler consists of a cylindrical tank, of varying length according to the number of coffee groups, which is made of AISI 300 series stainless steel. Each unit is subjected to a hydraulic test, at a pressure of 18 bar, and has an operating pressure of 9 bar. The following table is a list of effective volumes and power ratings according to the number of groups installed:

2 groups	3.4 liters	1400 Watts
3 groups	5.0 liters	1600 or 1900 Watts
4 groups	3.4+3.4 liters	1400+1400 Watts (2 Boilers Installed)

Covers are installed at either end of the cylindrical tank and on one of them there is a housing for the water heating elements. The temperature of the coffee boiler is maintained by an electronic temperature controller (PID capable) with an accuracy of 0.2°C. The brewing groups are installed on the boiler.

• Brewing groups

They consist of a precision casting made of stainless steel. The brewing group accepts the portafilter used to hold the ground coffee; Hot water under pressure flows through the brewing group, through the portafilter basket, through the portafilter spout, and into the cup(s) after the brew button has been pressed preparing espresso.

• Exterior cover

It consists of a stainless sheet steel body. The structure has been the object of specific studies to provide good aesthetics, to lower ergonomic costs for the operator and to reduce the chance of damage to a minimum.

• Water pump

The water pump, is a differential pressure, “positive-displacement” type installed on the water supply tubing and is set-up to operate anytime the coffee groups are activated, and through an autofill system whenever the steam boiler needs to be replenished.

3. Installation

WARNING

The machine is intended to be permanently connected to fixed wiring, and it is mandatory that a residual current device (RCD) with a rated residual operating current not exceeding 30mA is installed.

MODEL/SERIES	GROUP	V/Hz	RATED POWER (W)	RATED INPUT (A)	COFFEE BOILER WATTAGE	STEAM BOILER WATTAGE	TOTAL WATTAGE	POWER CORD SIZE (mm ²)
GB/5	2GR	AC220V/50-60Hz AC208V-240V/50-60Hz AC380V/50-60Hz	4600	21	1400	3000	4600	3/5 WIRES x 4mm ²
FB/80	2GR	AC220V/50-60Hz AC208V-240V/50-60Hz AC380V/50-60Hz	4600	21	1400	3000	4600	3/5 WIRES x 4mm ²
GB/5	3GR	AC220V/50-60Hz AC208V-240V/50-60Hz AC380V/50-60Hz	6100	28	1900	4000	6100	3/5 WIRES x 6mm ²
FB/80	3GR	AC220V/50-60Hz AC208V-240V/50-60Hz AC380V/50-60Hz	6100	28	1900	4000	6100	3/5 WIRES x 6mm ²
GB/5	4GR	AC220V/50-60Hz AC208V-240V/50-60Hz AC380V/50-60Hz	8000	35	2800	5000	8000	3/5 WIRES x 10mm ²
FB/80	4GR	AC220V/50-60Hz AC208V-240V/50-60Hz AC380V/50-60Hz	8000	35	2800	5000	8000	3/5 WIRES x 10mm ²

POWER CORD SINGLE PHASE:		POWER CORD MULTIPHASE:	
3 X WIRES	1 X BLUE (NEUTRAL)	5 X WIRES	1 X BROWN (PHASE) 1 X BLUE (NEUTRAL)
220V	1 X BROWN (PHASE)	380V	1 X GRAY (PHASE) 1 X YELLOW & GREEN (GROUND)
	1 X YELLOW & GREEN (GROUND)	4 X WIRES	1 X BLACK (PHASE)
		220V	

WARNING

THE DETAILS ON THE LEFT DESCRIBE HOW TO CONNECT EACH WIRE TO THE PLUG. RESPECT ALSO THE LOCAL SAFETY REGULATIONS.

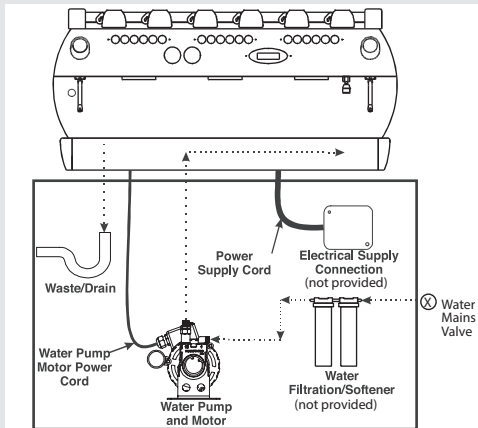

Fig. 2 - Installation Guide

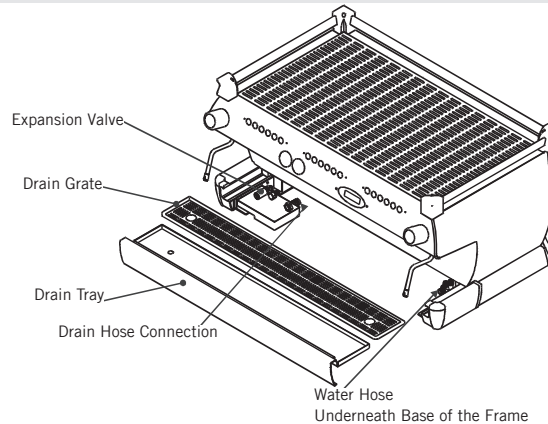

Fig. 3 - Installation Nomenclature

▲ WARNING ▲

At each installation, the machine should be equipped with a new set of tubes for plumbing and related gaskets.

▲ WARNING ▲

Water pressure supply must be between 0,2 and 0,6 MPa if sufficient pressure is not available we suggest that an additional water supply system is used.

▲ WARNING ▲

Before making any electrical connections make sure that the two strain relief connectors are firmly secured to the body of the machine in order to prevent inadvertent stress on the power cables.

▲ WARNING ▲

This machine should not be installed in kitchens.

▲ WARNING ▲

Hazardous voltage disconnect from power supply before servicing.

▲ WARNING ▲

The motor pump must be situated close to the machine in an accessible place for maintenance but not for accidental interference and where there is an optimal air circulation.

▲ WARNING ▲

The manufacturer declines any responsibility for any event leading to liability suits whenever grounding has not been completed according to current local, national, and international regulations and electrical codes, or other electrical parts have been connected improperly.

▲ WARNING ▲

This appliance is not intended for use by persons (including children) with reduced physical, sensory or mental capabilities, or with lack of experience and knowledge, unless they have been given supervision or instruction concerning the use of the appliance by a person responsible for their safety.

▲ WARNING ▲

- U.S.A. and CANADA only - Do not connect to a circuit operating at more than 150V to ground on each leg.

▲ WARNING ▲

This machine is not suitable for outdoor use. Jets of water should not be used to clean the machine, nor should it be placed where water jets are used.

▲ WARNING ▲

The Coffee Boiler and Steam Boiler contain water at elevated temperature. Water temperature over 125°F / 52°C can cause severe burns instantly or death from scalding (Coffee Boiler 207°F/97°C - Steam Boiler 256°F / 124°C)

▲ WARNING ▲

Replace fuses with the same size, type and rating F1 = 2A, 250V

▲ WARNING ▲

In order to prevent cracks or leakage: do not store or install the Coffee machine in places where in boiler or hydraulicsystem to freeze.

Note:

- The drinking water mains valve and the circuit breakers for the electrical system need to be located in the most convenient position for the operator to access them easily and quickly.
- The machine should be placed on a flat counter and must be placed in settings with the following temperatures:
Minimum room temperature: 5°C/41°F;
Maximum room temperature: 32°C/89°F.
- If the machine has been temporarily housed in settings with a room temperature of less 0°C/32°F, the machine must be placed in a warmer environment in order to gradually defrost the hydraulic system prior to use.
- Water pressure supply must be between 0,2 and 0,6 MPa.
- This machine complies with the standard 61000-3-11, the impedance at the supply interface must be $Z_{max}=0.17 \Omega$.

Water specifications table

		Min.	Max.
T.D.S.	ppm	90	150
Total Hardness	ppm	70	100
Total Iron (Fe ⁺² /Fe ⁺³)	ppm	0	0,02
Free Chlorine (Cl ₂)	ppm	0	0,05
Total Chlorine (Cl ₂)	ppm	0	0,1
pH	value	6,5	8,5
Alkalinity	ppm	40	80
Chloride (Cl ⁻)	ppm	not more	30

N.B.: Test water quality (the warranty is void if water parameters are not within the range specified in the section “installation”)

1) Installation on the counter

The image below shows the recommended method to drill the hole on the counter.

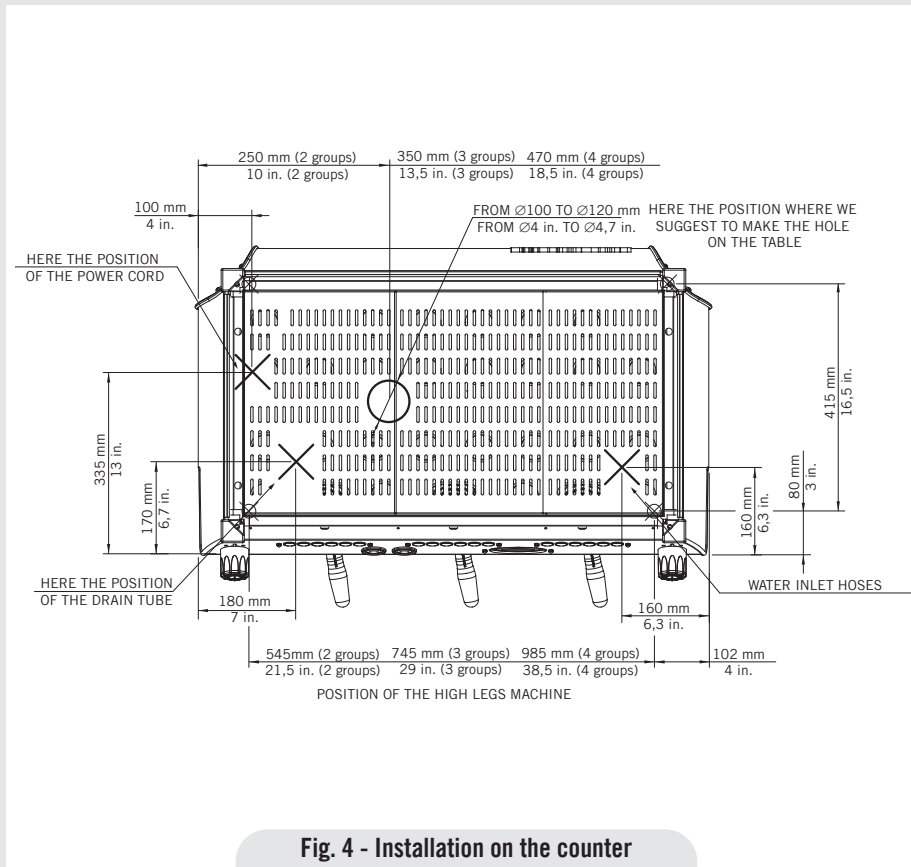

Fig. 4 - Installation on the counter

2) Accessories

Check the package to make sure that the following accessories are included:

- a number of 1-dose and 2-dose portafilters corresponding to the number of groups;
- replacement 1-dose and 2-dose filters (one of each)
- 1 tamper
- 1 blind filter
- cleaning detergent, for the groups
- 3 stainless steel braided hoses for water connections
- 1,5 mt of reinforced plastic tubing for drainage
- 1 hose clamp

In order to proceed with installation, it is necessary that the following are available:

- Pipes carrying drinking water with a **3/8" G (BSP)** end connection; **(3/8" Compression for USA and Canada)**
- Electrical Supply according to the specification of the espresso machine purchased:
- Single/Three phase 220VAC - 50/60 Hz electrical connection with ground, protected socket and approved interlock switch
- Single phase 200VAC - 50/60 Hz electrical connection with ground, protected socket and approved interlock switch
- Three-phase, 380VAC - 50 Hz electrical connection with neutral +

ground, near the bench on which the machine is installed and terminating in a suitable protected fivepole socket equipped with an approved interlock switch

- Waste water drain system

3) Water test kit

In order to enable you to check if your water supply is within the suggested ranges, La Marzocco machines will be equipped with two units of a quick water test kit (see image below) including 6 test-strips and instruction cards.

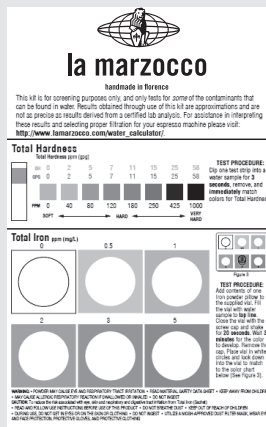

The parameters that you can measure are Total Hardness, Total Iron, Free Chlorine, Total Chlorine, pH & Total Alkalinity, Chlorides. Ideally, you should perform a test on the

water BEFORE the water treatment system and again AFTER the water system in order to verify if this is actually matching our suggested ranges.

Once the test has been performed, learn which treatment system is most appropriate for your particular water supply by filling out the online water calculator on our website: LA MARZOCCO WATER CALCULATOR (http://www.lamarzocco.com/water_calculator/).

4) Water supply connection

In order to connect the machine up to the water mains proceed according to the indications given in the chapter about Installation and in compliance with any local/national safety standards of the location in which the machine is being installed.

The equipment is to be installed with adequate backflow protection to comply with applicable federal, state, and local codes.

To guarantee a correct and safe functioning of the machine and to maintain an adequate performance level and a high quality of the beverages being brewed it is important that the incoming water be of a hardness greater than 7°f (70ppm, 4°d) and less than 10°f (100ppm, 6°d), pH should be between 6.5 and 8.5 and the quantity of chlorides be less than 30mg/l . Respecting these values allows the machine to operate at maximum

efficiency. If these parameters are not present, a specific filtration device should be installed, while always adhering to the local national standards in place regarding potable water.

Then connect the inlet of the water filter/softener (if present) to the drinking water supply using one of the supplied stainless steel braided hoses. Before connecting the filter to the water pump, flush the water supply line and the filtration system in order to eliminate any residual particles which could otherwise get stuck in taps or valves thus preventing them from working properly. Connect the water supply connection of the espresso machine to the water pump outlet using one of the supplied stainless steel braided hoses. Then connect the water pump inlet to the water filter/softener outlet (if present).

Note: The water pump is a differential pressure volumetric pump and has been designed to be used exclusively with cold water. Make sure that water is always present while the pump is operating, otherwise air can be introduced into the brew boiler causing an undesirable condition and the pump can be damaged.

5) Electrical connections

a) Power supply cord

- This is the main power supply cable that provides power to the entire espresso machine. There are different types of cable

based upon the electrical requirements of the espresso machine purchased

- 200/220VAC 1 Phase 3-core cable with 2.5/4/6/10mm² cross section or AWG 12/10/8 (for UL version), secured to espresso machine via a strain relief connector
- 220VAC 3 Phase 4-core cable with 4 mm² cross section for versions with 1, 2, 3 and 4 groups secured to espresso machine via a strain relief connector
- 380 VAC 3 Phase 5-core cable with 2.5/6 mm² cross section for versions with 1, 2, 3 and 4 groups secured to espresso machine via a strain relief connector.

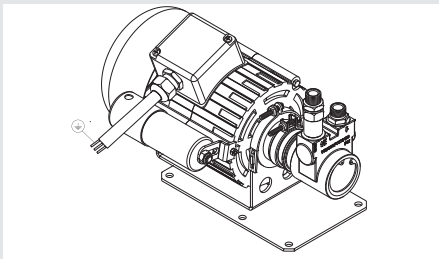

b) Water pump motor power cord

This is the power supply for the water pump motor. The internal electronics will switch the pump motor on when needed.

- 3-core cable with 1.5 mm² cross section or 3-core AWG 16 (for UL version) secured to espresso machine via a strain relief connector.

c) Quick connection between the water pump and the espresso coffee machine

The electrical connection must be made through the use of the connectors, as shown in the following figures:

- View of the connectors;

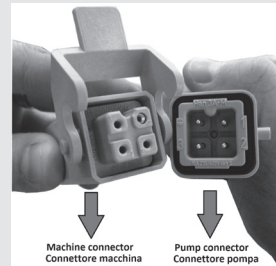

- Cable connection;

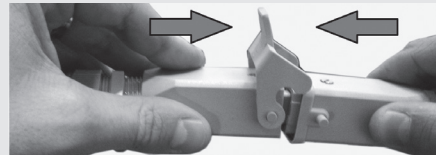

- Cable tightening;

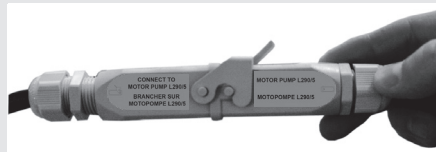

6) Waste water drain connection

The espresso machine drain is to be connected by means of the included reinforced plastic tubing. Connect one end of the reinforced plastic tubing to the drain hose connection on the left side of the espresso machine, secure with included hose clamp. Connect the other end to a suitable waste water collection system.

In case such a system is not available, drained liquids may be collected in a suitable bucket. Any necessary drain pipe extensions should be the same tubing specifications of what supplied with the machine when purchased and suitable hose clamps.

4. Machine Operation and Coffee Preparation

CAUTION

Never remove the filter holder when water is being delivered. This operation can be extremely dangerous since the high pressure built-up inside the blind filter would spray out hot and slightly caustic water, which may cause severe burns. The Coffee Boiler contains water at elevated temperature. Water temperature over 125°F / 52°C can cause severe burns instantly or death from scalding.

WARNING

The machine must not be dipped in, nor splashed with, water in order to clean it. For cleaning operations, please follow the instructions listed below very carefully.

WARNING

This machine is designed only for preparing coffee and hot drinks.

IMPORTANT

To improve the flavor of the espresso, the temperature of the water in the coffee boiler and therefore of the groups may eventually be raised or lowered via the digital display (please consult the Software Programming Manual for detailed instructions).

1) Starting the espresso machine

a) Filling the boilers with water

Once the installation procedures have been completed, it is necessary to fill the boiler tanks with water. Complete the following procedure to properly fill the boiler tanks:

• Coffee boiler

The water flows inside the coffee boiler directly, as soon as the water system and water filter/softener taps (if present) are opened. Since the inflow of water will compress the air in the boiler it will be necessary to remove or “bleed” the air from the coffee boiler. All air must be removed in order to completely “saturate” the coffee boiler/group assemblies. To

remove the air from the boiler, “bleed the groups”, it will be necessary to remove the group cover from the top of the machine. First remove the cup tray grates from the top of the machine exposing the cup tray. Remove the screws securing the group cover and then remove it. Once removed the top of the groups will be exposed. Loosen the bleed screws one at a time (see fig.4) to allow air to escape until water flows from below the screw head.

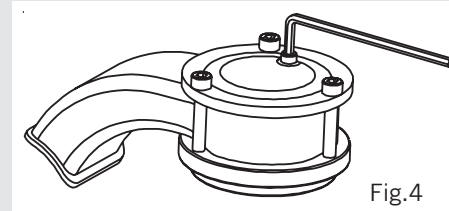

Tighten the screw to stop the water from flowing. Over tightening can cause damage to the sealing washer and the group cover. Repeat this procedure for all groups. Once all air is removed from the coffee boiler, reinstall the group cover by following the removal instructions in reverse.

• Steam boiler

Turn the main switch (item 1 in Fig. 1) to position “1” or ON, the automatic steam boiler level gauge will be switched on, activating the auto-fill solenoid valve and

the motor pump. This will fill the steam boiler to a predetermined level and will shut off when full.

Note: It may happen that the air inside the steam boiler builds up pressure (which may be detected through the pressure gauge - item 2, fig. 1) when the water is allowed to flow in; this “false” pressure must be eliminated by opening the steam valves (item 8, Fig. 1).

b) Turning the espresso machine on

Once you have completed these procedures, check the display. Press enter to confirm that the preceding procedures are complete.

The installation is now complete and the espresso machine should be heating to the operating temperatures.

2) Waiting for the espresso machine to heat to operating temperature

During this time, it may happen that the pointer of the coffee boiler pressure gauge reaches as high as 14-15 bar. This may happen anytime that the heating element is in the on condition. In this case it is necessary to adjust the expansion valve (Fig. 3) in such a way that the pressure may never exceed 11-12 bar. In normal operating conditions, the coffee boiler pressure gauge can read anywhere from 0-12 bar.

When brewing, the pressure should be set to 9 bar.

When the steam boiler reaches operating temperature, the light on the Tea dispense button will light.



When the espresso machine is ready to operate all lights on the keypads will light.

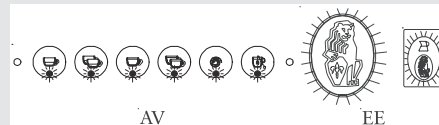

3) Brewing after first installation

Once the first installation procedures are finished, before proceeding with brewing coffee, hot water and steam, please follow these steps:

- Engage the portafilters by inserting them into each group, brew water through each group for at least two minutes.
- Being careful to avoid burns, turn on each steam wand for at least one minute.
- Turn on the hot water valve for the time necessary to allow the following quantities of water to be brewed:

At least 1 liter for a 1/2 group machine

At least 2 liters for a 3 group machine

At least 3 liters for a 4 group machine

4) Installing the portafilters

Install the portafilter(s) by inserting them into the group and rotate the handle from left to right. When the portafilters are inserted properly, you can press any of brew buttons to start the flow of water through the portafilter. You should allow hot water to pass through the empty portafilter(s) for a few seconds each time, in order to pre-heat the portafilter.

Note: It is important to leave the portafilters installed in the espresso machine when not in use. The portafilter must remain heated for the brew process to function correctly.

5) Water pump

Whenever you are brewing coffee, you can adjust the pump pressure by turning the by-pass screw (below the plug located on the side to which the pump power supply is connected) clockwise to increase and counter-clockwise to reduce pressure. Adjust pressure only when at least one group is brewing coffee.

Note: When the heating element in the coffee boiler is energized, the water will expand increasing the start-up pressure. Once the maximum pressure is reached, the expansion (safety) valve should start working by discharging a few drops of water, in order to prevent such pressure

from exceeding 11-12 bar.

In case the pressure exceeds 12 bar, you must adjust the expansion valve by unscrewing the cap slightly. If this is not sufficient, remove the valve and clear away any calcium deposits. This remedy is valid also in case the valve remains open in the drain position (i.e. the pressure cannot increase to 8 bar approx.).

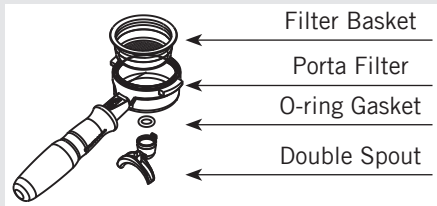

6) Brewing coffee

It is now possible to remove one of the portafilters to make an espresso beverage. Place some ground coffee in the filter itself: 1 dose (approximately 6-7 g) for the small filter, 2 doses (2 approximately 12-15 g) for the larger filter. Press down on the ground coffee with the supplied tamper and install the filter holder up again to the bottom of the group and then press a button (AV model) to begin the brewing process, or move the paddle lever (MP model see picture below).



Note: Some baristas believe it is important to press the brewing button prior to installing the portafilter to allow the water to flush any remaining coffee oils and particles from the group. Some also flush just after brewing coffee for the same reason. Please experiment to find the best possible procedure for you.

7) Controlling the brew process using volumetric programming (AV model only)

This espresso machine allows the volumetric programming of each of the first two buttons on each group (numbered left to right). Please consult the Software Programming Manual for further instructions.

8) General notes for coffee preparation

The portafilters must remain heated since they are at the lowest position of the group itself, and they are partially isolated due to the rubber gasket between them. This can be accomplished by leaving the portafilters installed in the machine when not in use. The portafilters may also be actively heated. This procedure may be carried out by brewing some hot water through the portafilter then turning off the water flow, before making coffee.

We recommend removing the spent coffee puck directly after brewing.

The size of the coffee granules is extremely important in preparing a good cup of coffee, other than the type of coffee mix used, quite obviously. The ideal grinding can be determined by making various coffees using the amount of ground coffee that you would normally use for each cup (we recommend at least 6-7g). The best grinding is that which allows coffee to flow out from the filter holder spouts neither too slowly (drop by drop) nor too quickly (quick light brown flow). A general rule is that a double dose should dispense approximately 25cc or 2 fluid oz. of espresso in approximately 25 seconds.

9) Cup Warmer

Press Cup Warmer Button for enabled or disabled the cup warmer. This function work in two modes continuous or timed (see the Software Programming Manual for further instructions).

5. Dispensing Steam and Hot Water

1) Steaming milk or other liquids

In order to allow for any condensed water in the wand to be released ALWAYS allow some steam to be discharged by turning on the valve before inserting the steam wand into the pitcher of liquid to be heated.

Dip one of the 2 steam wands (part 8, fig. 1) which are connected to the steam valve, into the liquid to be heated, turn the steam knob (part 9, fig. 1) gradually until steam comes out at the end of the wand.

The steam will transfer heat to the liquid raising its temperature up to boiling point. Be careful not to allow liquid to overflow in order to avoid severe burns.

In order to prepare milk for making cappuccino with the right amount of foam, go through the following steps:

- Place the container half-full of milk under the steam wand, open the steam valve and heat the milk to desired temperature.

- Lower the container so as to bring the wand end to a point just below the surface of the milk; at this point, move the container up and down just enough to dip the nozzle end in and out of the milk until you get the right amount of foam. You can then pour this milk into a cup containing warm espresso and you will end up with a fresh cup of cappuccino.

In order to prevent the heated liquid from being sucked back into the steam boiler it is recommended that you purge the steam valve and steam wand by opening the valve for a few seconds to allow steam to escape to the atmosphere from the end of the steam wand. Failure to do so can cause the heated liquid to transfer from the heated liquid container to the steam boiler (via vacuum created from cooling parts). This condition is undesirable and can cause contamination in the steam boiler.

2) Preparing tea and other hot drinks

You may dispense hot water by using the fixed nozzle (item 10 fig 1). To dispense hot water, press the tea water button on the right most group.

This button commands the hot water delivery.



The volume of water delivered may be adjusted via the display (see the Software Programming Manual for further instructions). The temperature of the water dispensed may be adjusted by adjusting the mixing valve.

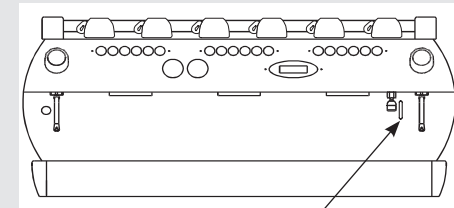

Hot Water Mix Valve

6. Maintenance and Periodic Cleaning Operations

▲ WARNING ▲

If the above-mentioned instructions are not adhered to the manufacturer cannot be held responsible for damage to persons or things.

▲ WARNING ▲

In order to prevent cracks or leakage: do not store or install the coffee machine in places where temperature may cause water in boiler or hydraulic system to freeze.

▲ WARNING ▲

The machine is intended to be permanently connected to fixed wiring, and it is advisable that a residual current device (RCD) with a rated residual operating current not exceeding 30mA is installed.

▲ WARNING ▲

The machine must be installed so that qualified technical personnel can easily access it for eventual maintenance.

▲ WARNING ▲

The machine must not be dipped in, nor splashed with, water in order to clean it. For cleaning operations, please follow the instructions listed below very carefully.

▲ WARNING ▲

Do not remove the filter holder while relative group is brewing hot liquids.

The Coffee Boiler contains water at elevated temperature. Water temperature over 125°F / 52°C can cause severe burns instantly or death from scalding.

▲ WARNING ▲

This machine is for professional use only and should be installed in locations where its use and maintenance is restricted to trained personnel.

▲ WARNING ▲

Jets of water should not be used to clean the machine, nor should it be placed where water jets are used.

1) Cleaning groups and drain wells

- Put a half teaspoon of detergent powder for coffee machines into the blind filter, supplied with the machine, and tighten it onto the group you want to clean by using a normal filter holder.
- Activate the automating rinsing (backflushing) routine (see the Software Programming Manual for more detailed instructions).
- Rinse the group using a normal filter, by running hot water through it several times

2) Cleaning filters and filter holders

- Put 2 or 3 teaspoons of detergent powder for coffee machines in about 1/2 a litre of water inside a heat-resistant container and heat.
- Dip filters and filter holders (but not the handles) in the heated solution and leave them fully submerged for about 30 minutes.
- Rinse thoroughly with clean water and run hot water through one group several times with the filters in place.
- Make one cup of coffee and discard in order to remove any unpleasant flavor.

3) Cleaning the drain collector

Remove the drain tray grill at least twice a week and clean, pull out the water drain collector and clean it thoroughly. Inspect and clean the drain well also, and remove any leftover grounds.

4) Cleaning the body

Wipe the stainless steel surfaces with a soft, non abrasive cloth in the direction of the glazing marks, if any. Do not use any alcohol or solvents whatsoever on painted or imprinted parts in order not to damage them.

5) Cleaning the hot water and steam nozzles

Steam nozzles must be cleaned immediately after use with a damp cloth

and by producing a short burst of steam so as to prevent the formation of deposits inside the nozzles themselves, which may alter the flavor of other drinks to be heated. Hot water nozzles must be cleaned periodically with a damp cloth.

6) Cleaning the diffuser screen

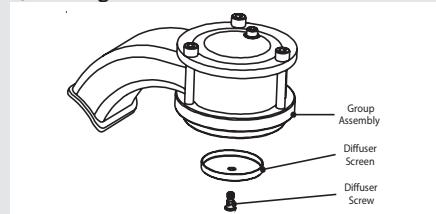

- Due to filter holder discharge operations (subsequent to coffee brewing), a certain amount of coffee grounds may slowly build-up on and obstruct, even partially, the diffuser screen. To clean it, you must first remove it by unscrewing the diffuser screw.

- Put 2 or 3 teaspoons of cleaning detergent for coffee machines in about 1/2 a litre of very hot water inside a heat-resistant container.
- Place the diffuser screen(s) and diffuser screw(s) in the solution and leave them fully submerged for about 30 minutes.

7) Cleaning the gigger

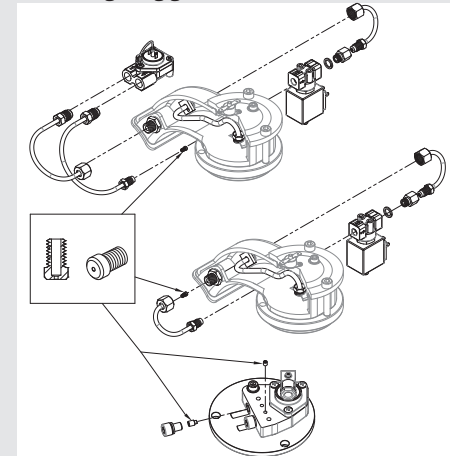

The gigger (or restrictor) on a GB5 group cap can be located under the solenoid valve. In order to access the gigger you must first turn off the water to the machine and de-pressurise the coffee boiler.

To remove the solenoid valve you will need a 4mm allen key. Loosen the two allen screws and lift off the solenoid body from the group cap. Be careful not to lose the two 'o' rings. The gigger can be removed from the hole in the group cap with a 2mm allen key.

Clean the gigger with a mild de-scaling solution and/or a fine wire (such as a guitar string)

Re-assembly is the reverse of dis-assembly.

8) Water Filter/Softener

Please see the documentation accompanying the water filter/softener for proper operating and cleaning instructions.

- **Steam boiler draining:** to activate this function you need to access the programming menu (see p. 52). Yearly, we recommend to fully drain the steam boiler by means of the specific drain cock located on the side of the boiler or under the boiler.

9) Depressurize the steam boiler

Press and hold the encoder knob to set the espresso machine to “OFF”, then push down the steam lever in order to depressurize the steam boiler.

IMPORTANT

If the machine has not been used for more than 8 hours or, in any case, after long periods of being idle, in order to use the machine to its full potential it is necessary

to perform some cleaning cycles before brewing beverages as follows:

- Groups: with the portafilters engaged in the groups brew water through each for at least two minutes
- Being careful to avoid burns, turn on each steam wand for at least one minute.
- Turn on the hot water valve for the time necessary to allow the following quantities of water to be brewed:
 - At least 1 liter for a 1/2 group machine
 - At least 2 liters for a 3 group machine
 - At least 3 liters for a 4 group machine

If the machine is not going to be used for long periods of time, it is advisable to follow these safety indications:

- Disconnect the machine from the water mains or interrupt the water connection via a mains tap.
- Disconnect the machine from the electrical mains.

7. De-Commissioning and Demolition

1) De-commissioning and demolition

Start by setting the main switch to the “0” or OFF position.

Disconnecting from the power outlet

Disconnect the espresso machine from the electrical network by switching off the associated circuit breaker or circuit protection device. Remove the power supply cord from the power connection. Remove the Pump Motor Power Cord from the water pump motor.

Disconnecting from the water system

Shut off the water supply by closing the specific tap located upstream of the water filter/softener inlet. Disconnect the water pipe at the water filter/softener inlet.

Remove the hose connecting the espresso machine to the water pump. Remove the reinforced plastic tubing on the drain connection.

At this point, the machine may be removed from the bar, being very careful not to drop it.

The machine is made out of various materials and therefore, if you do not intend to put it back in service, it must be taken to a special disposal company which will select the materials which can be recycled and discard the others.

Current regulations make it illegal to discard such machine by leaving it on public grounds or on any private property.

Recycling notice: Warning for the protection of the environment.

Used Electrical and electronic waste contains hazardous but also valuable and scarce materials which should be recovered and recycled properly. We kindly ask that you contribute to the protection of the environment and natural resources by delivering used equipment to the relevant recycling locations if such locations are available in your country.



8. Mandatory Maintenance and Check-up Operations

These operations are in addition to the Maintenance and Periodic Cleaning Operations as specified in Chapter 7.

The following maintenance and check-up operations should be carried out by a qualified technician.

The time required for the periodic maintenance is determined by the quantity of daily work and/or coffee consumption.

N.B. These periodic maintenance operations are not covered by warranty.

EVERY THREE/FOUR MONTHS

- | | | | |
|---|--|---|---|
| <ul style="list-style-type: none">▪ Replace group gaskets▪ Replace diffuser screens▪ Clean auto-fill probe▪ Check vacuum breaker for proper operation▪ Inspect water inlet valve▪ Inspect drain system for leaks or clogs▪ Check flow rate for each group | <ul style="list-style-type: none">▪ Check brew temperature▪ Check that brew pressure is at 9bar▪ Check all switches for proper operation▪ Check/note water hardness (Water quality must be within the range of parameters specified in the chapter on Installation, | <p>otherwise warranty is voided)</p> <ul style="list-style-type: none">▪ Check filter basket condition <p>If AV Model:</p> <ul style="list-style-type: none">▪ Check shot volumes▪ Test flowmeter's ohm value (ohm value is acceptable if greater than 1.8 K ohm, and less than 2.2 K ohm | <p>If MP Model:</p> <ul style="list-style-type: none">▪ Rebuild MP valve |
|---|--|---|---|

EVERY SIX/EIGHT MONTHS (in addition to the above)

- Rebuild steam assemblies

EVERY YEAR (in addition to the above)

- | | |
|---|--|
| <ul style="list-style-type: none">▪ Replace portafilter baskets▪ Inspect group valve plungers▪ Inspect vacuum breaker▪ Inspect expansion valve▪ Inspect electrical wiring condition | <ul style="list-style-type: none">▪ Inspect boilers safety switches▪ Replace over-pressure valve (safety valve)▪ Accurate control of the tightness at 2,4Nm of each cable on the terminal block. |
|---|--|

EVERY 3 YEARS (in addition to the above)

- Check the condition of the inside of boilers and if necessary rinse out with a proper cleaning product allowed for food and beverage appliances.

9. Software Programming Guide

AV - Table of Contents

Digital Display	page 25	Times Cup Heating	page 42	Pre-Programmed Backflush	
Programming Keypad	page 26	Pre-Brewing	page 44	(Back Flushing) Routine	page 63
Programming Mode	page 27	Filter Alarm	page 45		
Initial Installation	page 28	Steam Boiler Automatic Fill	page 46	Troubleshooting	page 64
Turning the Espresso Machine On	page 29	Tea Water	page 48		
Turning the Espresso Machine Off	page 30	Steam Boiler Pressure Regulation	page 49	EE - Table of Contents	page 65
		Steam Boiler Temperature			
		Correction	page 50		
“Barista” Programming		Open Valve	page 51		
Water Volume Programming	page 31	Drain Steam Boiler	page 52		
Nominal Coffee Boiler		Safety Valve	page 53		
Temperature	page 32	Technician Password Assignment	page 54		
Cup Heating	page 33	Water Volume Programming	page 55		
Doses Reading	page 34	Nominal Coffee Boiler			
Clock Adjust	page 35	Temperature	page 57		
Auto On/Off	page 36	Cup Heating	page 58		
		Doses Reading	page 59		
“Technical” Programming		Clock Adjust	page 60		
Language	page 37	Auto On/Off	page 61		
Temperature Adjustment	page 38				
Total Doses	page 39				
Cronos Function	page 40				
User Name	page 41				

Description

- This espresso machine has a CPU and many configurable settings.
- Additionally, there are many feedback controls employed in this espresso machine to troubleshoot problems should they occur.
- The following is a brief introduction to the controls and display and how they interact with the operator.

Digital Display





The digital display (display) is a backlit display capable of displaying 2 lines of 16 characters. The display enables the operator to interact with the espresso machine to visibly change parameter values. The display also provides valuable information to the operator. There are several warnings that the can be displayed to alert the operator of an unusual condition or a fault. Additionally, simple messages are displayed alerting the operator that an action has been started or that a process needs to begin.

Programming Keypad





The programming keypad is always located as the group 1 controls (left most keypad). These are the buttons used to change values within the configurable parameters.

The  and the  buttons are used to change the values of the individual parameters.

The  button is used to scroll through the parameters. Additionally, this button also confirms values within the parameters.

The  button confirms the values within the parameters. Additionally it is also used to scroll through the values within the parameters.

The  button is used to access the programming mode.

The  button is used to turn on and turn off the espresso machine. This button can also be used to exit the programming mode.

Accessing Programming Mode

Programming Mode















Description

- To change any configurable parameter the operator must first enter into the programming mode.
- There are several levels within the programming mode that allow the restriction of specific parameters depending upon the password entered.

The two programming levels are as follows:

- **Barista Programming** - No password necessary. Limited parameters are available.
- **Technical Programming** - Technica password needed. Barista level parameters plus additional parameters are available.

Display	Operating Procedure
LaMarzocco 09:30	1 Press and hold the  button on the group 1 keypad. After approximately 5 seconds the following display appears.
Water Volume Programming	2 This is the Barista Level. Press the  button to scroll through the available parameters.
	3 When finished, press  to exit programming mode.
LaMarzocco 09:30	4 Press and hold the  button on the group 1 keypad. After approximately 10 seconds the following display appears.
Password ?????	5 Using a combination of the following buttons (the first 5 buttons on the group 1 keypad) enter the appropriate 5 digit password.      
	6 The parameters available after entering the password are dependant upon the password entered. If a technician password is entered then the technician level parameters will be made available....etc. Press  to scroll through the available parameters.
	7 When finished, press  to exit programming mode.

Initial Installation

Initial Installation



Description

- This is the initial display shown when first installing this espresso machine.
- **Note:** If machine has been bench tested by your local distributor you will not see this first display.

Display	Operating Procedure
<p>The first display shows the text 'First installat.' and 'Enter to confirm' in a rectangular box. The second display shows 'OFF' on the left and '09:30' on the right, also in a rectangular box.</p>	<ol style="list-style-type: none"> <li data-bbox="359 642 1421 729">1 Press the  button on the group 1 keypad to confirm that this is in the initial installation of this espresso machine. <li data-bbox="359 755 1185 784">2 Please refer to the section “Turning the Espresso Machine On” to continue

Start Up Procedures

Turning the Espresso Machine On



Description

- The following is the procedure for turning on the power to the espresso machine.
- Please follow the procedures carefully to avoid any damage to the espresso machine.

NOTE: If the message “First Installat. Enter to confirm” appears in the display, please see the preceding page entitled “Initial installation”.

Display	Operating Procedure
	<p>1 The following is the procedure for turning on the power to the espresso machine. Turn the Main Switch to the On position.</p>
	<p>2 The message at left will be displayed briefly. This message indicates the revision level of the software installed in this espresso machine.</p>
	<p>3 To complete the turn on process, press the button and the display at left is shown. The machine begins to automatically fill the steam boiler until full. The display is asking if you have completed the coffee boiler air bleeding process (of the coffee boiler). When this process is complete, press the enter button. If the screen does not change, wait until the steam boiler is completely full and try again.</p>
	<p>4 The espresso machine is now ON and you should see one of the two following displays.</p>
	<p>5 When the espresso machine reaches operating temperature the lights on all keypads will light indicating that the espresso machine is ready to use.</p>



WARNING



HAZARDOUS VOLTAGE DISCONNECT FROM POWER SUPPLY BEFORE SERVICING

Shut Down Procedures

Turning the Espresso Machine Off



Description

- The following is the procedure for turning off power to the espresso machine.
- Please follow the procedures carefully to avoid any damage to the espresso machine.
- This machine has two off settings:
 - One setting turns off all of the components in the espresso machine.
 - The other turns off power to the complete espresso machine.

Display	Operating Procedure
	1 The following is the procedure for safely turning off the espresso machine.
	2 Press and hold the button (approximately 3 seconds). The display changes to the following:
	3 This is the OFF setting used in the normal operating conditions. During servicing or other conditions that warrant it the main switch should be turned to the OFF or "0" position.
	4 The main switch is shown in two positions: 0 and 1. The OFF/ON setting is shown in two positions: OFF and ON.
	5 The espresso machine is off and display should be blank. It is important to follow this procedure when turning off the machine. Failure to do so can damage the electronics.



WARNING









HAZARDOUS VOLTAGE DISCONNECT FROM POWER SUPPLY BEFORE SERVICING

Water Volume Programming



Description

- This parameter allows the operator to program the water volume (shot volume) for the individual buttons on the keypad.
- The saved program is a number. This number relates to the number of pulses the flowmeter delivers to the CPU. Once the programmed number of pulses is received by the CPU, the flow of water is stopped.

Display	Operating Procedure
LaMarzocco 09:30	1 Press and hold the  button on the group 1 keypad until the following is displayed (approximately 5 seconds):
Water Volume Programming	2 Press the  button on the group 1 keypad again. The lights on the first 4 buttons will light and the light on the continuous button will begin flashing. The flashing light indicates the keypad is in programming mode
	3 While in programming mode, press any of the first 4 buttons. When the desired amount of water has been dispensed, press the same button again to stop the flow of water. Continue this same procedure for all buttons that programming is desired.
	4 Once the first 4 buttons are programmed, press the  button to exit programming mode
	5 To program the tea water dispense button, repeat procedure 1 then press the  button on the corresponding keypad that you wish to program. When the light begins to flash, press  the button. When the desired amount of water has been dispensed, press the  button again to stop the flow of water. When finished  press the button to exit programming mode.
	NOTE: The programming completed for group 1 keypad will be copied to all subsequent keypads. If other programming is desired for subsequent keypads, follow procedure 1 and 2 substituting the subsequent group keypad number for procedure 2. It is recommended to program each group separately.









“Barista” Programming

Nominal Coffee Boiler Temperature



Description

- This parameter is set at the factory at a preset nominal temperature.
- The set temperature of this parameter differs from the actual temperature of the water exiting the group to the coffee.
- The temperature of the boiler is measured at the most critical point in the boiler when temperature fluctuation is the greatest.
- The temperature of the water exiting the group head is held constant by means of the mass of the group casting. Even though the temperature of the boiler may vary a few degrees, the temperature of the water exiting the group is constant.
- To set the temperature of any espresso machine it is important to measure the temperature of the water exiting the group.

Display	Operating Procedure
LaMarzocco 09:30	1 Press and hold the  button on the group 1 keypad until the following is displayed (approximately 5 seconds):
Water Volume Programming	2 Press the  button on the group 1 keypad until the following appears:
Coffee Boilers Temperatures	3 Press the  button to select the coffee boiler you wish to change temperature.
Coffee Boiler 1 202.5°F 202.6°F	4 Press the  or the  button to change the temperature on the displayed boiler. The measured temperature appears on the left and the set temperature appears on the right side of the display. Once the desired temperature is selected press the button  to confirm the selection.
	5 Repeat procedure 5 for all subsequent boilers (if installed).
	6 When finished, continue to the next parameter  or press  to exit programming mode.







“Barista” Programming

Cup Heating



Description

- This parameter allows the user to enable or disable the cup heating routine.
- The cup heater is an option ordered from the factory, not available in the USA & Canada.
- Additional parameter settings are available in the factory level parameters under Cup Heating Times.

Display	Operating Procedure
LaMarzocco 09:30	1 Press and hold the  button on the group 1 keypad until the following is displayed (approximately 5 seconds):
Water Volume Programming	2 Press the  button on the group 1 keypad until the following appears:
Cup heating OFF	3 Press the  or the  button to change to ON or OFF. Once the desired condition is displayed press the  button to confirm.
	4 When finished, continue to the next parameter  or press  to exit programming mode.







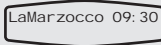

“Barista” Programming

Doses Reading

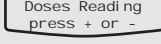

Description

- This parameter allows the user to review the total doses dispensed for each button.
- The number displayed is the total number of times the individual button has been activated.

Display	Operating Procedure
	1 Press and hold the  button on the group 1 keypad until the following is displayed (approximately 5 seconds):
	2 Press the  button on the group 1 keypad until the following appears:
	3 Press the  or the  button to scroll through the values for each button.
	4 When finished, continue to the next parameter  or press  to exit programming mode.









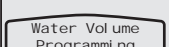

“Barista” Programming

Clock Adjust

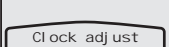

Description

- This parameter allows the user to set the time of day and the day of the week.
- This parameter is used by the “Auto On/Off” parameter

Display	Operating Procedure
	<p>1 Press and hold the  button on the group 1 keypad until the following is displayed (approximately 5 seconds):</p>
	<p>2 Press the  button on the group 1 keypad until the following appears:</p>
	<p>3 The hour value should be flashing. Press the  or the  button to change the hour.</p>
	<p>4 Press the  button to change to minute value and again to change to the day of the week value. Follow step 3 to change these values.</p>
	<p>5 When finished, continue to the next parameter  or press  to exit programming mode.</p>











“Barista” Programming

Auto On/Off



Description

- This parameter allows the user to program the espresso machine to turn on at a preset time and turn off at a preset time.
- This feature also allows the espresso machine to remain in the off condition for one repeating closed day.







Display	Operating Procedure
LaMarzocco 09:30	1 Press and hold the  button on the group 1 keypad until the following is displayed (approximately 5 seconds):
Water Volume Programming	2 Press the  button on the group 1 keypad until the following appears:
Auto On/Off On: --.--	3 The hour value should be flashing. Press the  or the  button to change the hour for the “On” time.
Auto On/Off Off: --.--	4 Press the  button to change to the minute value. Follow step 3 to change this value.
Auto On/Off Off: --.--	5 Press the  button again to change to hour value for the “Off” time. Follow step 3 to change this value.
Auto On/Off Off: --.--	6 Press the  button again to change to minute value for the “Off” time. Follow step 3 to change this value.
Closed On -----	7 Press the  button again to change to the “Closed On” value. Follow step 3 to change this value
	8 When finished, continue to the next parameter  or press  to exit programming mode.

Language

Description

- This parameter allows the technician to change the language of the display.



Display	Operating Procedure
LaMarzocco 09:30	1 Press and hold the  button on the group 1 keypad until the following is displayed (approximately 10 seconds):
Password ?????	2 Enter the 5 digit technician password using buttons 1-5 on the group 1 keypad. Once accepted the following appears:
Language ENGLISH	3 Press the  or the  button to change the display language. You may choose from Italian, Francaise, English or Deutsch. Once the desired selection is made press the  button to confirm the selection.
	4 When finished, continue to the next parameter  or press  to exit programming mode.

“Technical” Programming

Temperature Correction



Description

- This parameter allows the technician to adjust the temperature of the individual coffee boilers.
- This procedure is best completed with an external temperature measuring device that measures the water exiting the group at the point of contact with the coffee.

Display	Operating Procedure
	1 Press and hold the button on the group 1 keypad until the following is displayed (approximately 10 seconds):
	2 Enter the 5 digit technician password using buttons 1-5 on the group 1 keypad. Once accepted the following appears:
	3 Press and hold the button on the group 1 keypad until the following appears:
	4 Press the button on the group 1 keypad one time and the following appears:
	5 Press the or the button to adjust the temperature higher or lower. Each block is equal to 0.9°F (0.5°C). Once the desired setting is made press the button to confirm and advance to the next boiler (if available).
	6 Repeat procedure 5 for all subsequent boilers.
	7 When finished, continue to the next parameter or press to exit programming mode.





“Technical” Programming

Total Doses



Description

- This parameter keeps a count of each dose that is produced with this espresso machine.
- This number cannot be adjusted nor reset.
- This number can be an important reference when troubleshooting the espresso machine.

Display	Operating Procedure
LaMarzocco 09:30	1 Press and hold the  button on the group 1 keypad until the following is displayed (approximately 10 seconds):
Password ?????	2 Enter the 5 digit technician password using buttons 1-5 on the group 1 keypad. Once accepted the following appears:
Language ENGLISH	3 Press the  button on the group 1 keypad until the following appears:
Total Doses 15	4 The number displayed is the total number of doses that this machine has produced
	5 When finished, continue to the next parameter  or press  to exit programming mode.

“Technical” Programming

Cronos Function (shot timer)



Description

- When enabled, this parameter displays a timer that times each shot.
- The corresponding timer is reset each time a button on the corresponding keypad is pressed
- When enabled, the Cronos Function is continuously displayed. User name will not be displayed when this parameter is enabled.

Display	Operating Procedure
	1 Press and hold the button on the group 1 keypad until the following is displayed (approximately 10 seconds)
	2 Enter the 5 digit technician password using buttons 1-5 on the group 1 keypad. Once accepted the following appears:
	3 Press the button on the group 1 keypad until the following appears:
	4 Press the or the button to change to ENABLED or DI SABLED. Once the desired condition is displayed press the button to confirm
	5 When finished, continue to the next parameter or press to exit programming mode.
	NOTE: When this parameter is ENABLED the display will be changed to the following (3 group version shown here):

“Technical” Programming

User Name



Description

- This parameter allows the technician to program a 16 character user name.
- The user name is displayed continuously on the display on the second line.
- The user name is not displayed when the Cronos Function is ENABLED.

Display	Operating Procedure
	1 Press and hold the button on the group 1 keypad until the following is displayed (approximately 10 seconds)
	2 Enter the 5 digit technician password using buttons 1-5 on the group 1 keypad. Once accepted the following appears:
	3 Press the button on the group 1 keypad until the following appears:
	4 The first character in the user name is flashing. Press the or the button to change the value. Once the desired condition is displayed press the button to advance to the next.
	5 When finished, continue to the next parameter or press to exit programming mode.
	The following is a listing of the available characters: ABCDEFGHI JKLMNOPQRSTUVWXYZ0123456789(): , , *+, - . /! , , #&=?@ (BLACK SPACE)







“Technical” Programming

Cup Heating



Description

- This parameter allows the technician to adjust the operating time of the resistance for the heating of the cups.
- This function is displayed only on the models of espresso machine equipped with this accessory.
- Press the button  it is possible to stop and to restart the cycle of the cup warmer.

Display	Operating Procedure
LaMarzocco 09:30	1 Press and hold the  button on the group 1 keypad until the following is displayed (approximately 10 seconds)
Password ?????	2 Enter the 5 digit technician password using buttons 1-5 on the group 1 keypad. Once accepted the following appears:
Language ENGLISH	3 Press the  button on the group 1 keypad until the following appears:
Cup heating Times	4 Press the  button to enter the menu.
Cup heating On 3 min	5 Move between the parameters with the buttons  or  to set the desired time. Press the button  to confirm the value.









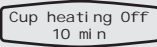

“Technical” Programming

Cup Heating

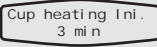

Description

- This parameter allows the technician to adjust the operating time of the resistance for the heating of the cups.
- This function is displayed only on the models of espresso machine equipped with this accessory.
- By press the button  it is possible also to stop and to restart the cycle of the cup warmer.

Display	Operating Procedure
	<p>6 Move between the parameters with the buttons  or  to set the desired time. Press the button  to confirm the value.</p>
	<p>7 Move between the parameters with the buttons  or  to set the desired initial time. Press the button  to confirm the value.</p>
	<p>8 When finished, continue to the next parameter  or press  to exit programming mode.</p>











“Technical” Programming

Pre-Brewing (Pre-Infusion)



Description

- This parameter allows the technician to enable or disable the pre-brewing (also called pre-infusion) function.
- Pre-brewing has two values to adjust. T(tot) is the total time for pre-brewing. T(on) is the amount of time that the brew valve is open during T(tot). The off time is calculated by subtracting T(on) from T(tot).

Display	Operating Procedure
LaMarzocco 09:30	1 Press and hold the  button on the group 1 keypad until the following is displayed (approximately 10 seconds)
Password ?????	2 Enter the 5 digit technician password using buttons 1-5 on the group 1 keypad. Once accepted the following appears:
Language ENGLISH	3 Press the  button on the group 1 keypad until the following appears:
Pre-Brewing DI SABLED	4 Press the  or the  button to change to ENABLED or DI SABLED. Once the desired condition is displayed press the  button to confirm.
Key 1 Group 1 Ttot: 20 Ton: 10	5 If ENABLED is chosen, the display then shows the values for T(tot) and T(on) for each button. Press  or the  to adjust a value and press  to advance to the next value.
	6 Repeat procedure 5 for each button (key) that you wish to activate pre-brewing. A setting of T(tot) = 0 and T(on) = 0 disables pre-brewing on the individual button.
	7 When finished, continue to the next parameter  or press  to exit programming mode.
	NOTE: The unit of measure for these values is 1/10 sec. Therefore a value of 10 equals 1 second.















“Technical” Programming

Filter Alarm



Description

- This parameter allows the technician to preprogram an alarm that notifies the user when the water filter requires service or replacement.
- When the programmed volume of water has passed through the espresso machine the error message “Change Filter” is displayed.
- A value of 0 (zero) disables the filter alarm parameter.

Display	Operating Procedure
LaMarzocco 09:30	1 Press and hold the  button on the group 1 keypad until the following is displayed (approximately 10 seconds)
Password ?????	2 Enter the 5 digit technician password using buttons 1-5 on the group 1 keypad. Once accepted the following appears:
Language ENGLISH	3 Press the  button on the group 1 keypad until the following appears:
Filter Alarm	4 Press the  button on the group 1 keypad until the following appears:
Change H2O Filtr. 0 liters	5 Press the  or the  button to change the volume of water required before filter servicing/replacing is recommended. When finished press  to confirm.
Water Flow 12 cc/sec	6 Press the  or the  button to change the estimated flow rate of water. Normally this value should not be changed. When the desired value is displayed press  to confirm.
	When finished, continue to the next parameter  or press  to exit programming mode.
	7 Note: To reset the function turn off the machine with the  button (press and hold approximately 3 seconds). Next, press and hold the  button while turning on using the  button.







“Technical” Programming

Steam Boiler Automatic Fill



Description

- This parameter allows the technician to select the activation of the water pump during the steam boiler auto- fill cycle.
- Only under unusual circumstances would the option of “without pump” be chosen.
- The electronics installed in this espresso machine give priority to the brew boiler for pressure. The activation of the auto-fill cycle during the brewing process can reduce the overall dispensing pressure in the brew boiler.
- During the auto-fill cycle, if a brew cycle is chosen, the auto-fill cycle is delayed until all brew cycles are complete.







Display	Operating Procedure
LaMarzocco 09:30	1 Press and hold the  button on the group 1 keypad until the following is displayed (approximately 10 seconds)
Password ?????	2 Enter the 5 digit technician password using buttons 1-5 on the group 1 keypad. Once accepted the following appears:
Language ENGLISH	3 Press the  button on the group 1 keypad until the following appears:
Filling-up with pump	4 Press the  or the  button to change to with pump or without pump. Once the desired condition is displayed press the  to confirm.
	5 When finished, continue to the next parameter  or press  to exit programming mode.

Steam Boiler Automatic Fill During Coffee Dispensing



Description

- This parameter allows the technician to Enable/Disable the steam boiler automatic filling while dispensing coffee.

Display	Operating Procedure
LaMarzocco 09:30	1 Press and hold the  button on the group 1 keypad until the following is displayed (approximately 10 seconds)
Password ?????	2 Enter the 5 digit technician password using buttons 1-5 on the group 1 keypad. Once accepted the following appears:
Language ENGLISH	3 Press the  button on the group 1 keypad until the following appears:
During Coffee Dispensing Enable FillingUp	4 Press the  or the  button to change to ENABLE or DISABLE. Once the desired condition is displayed press the  button to confirm.
	5 When finished, continue to the next parameter  or press  to exit programming mode.







“Technical” Programming

Tea Water



Description

- This parameter allows the technician to select the activation of the water pump during hot water dispensing.
- When hot water is drawn from only the steam boiler this parameter should be set to “without pump”.
- If the optional adjustable temperature hot water dispense valve is installed, this parameter is set to “with pump”.

Display	Operating Procedure
LaMarzocco 09:30	1 Press and hold the  button on the group 1 keypad until the following is displayed (approximately 10 seconds)
Password ?????	2 Enter the 5 digit technician password using buttons 1-5 on the group 1 keypad. Once accepted the following appears:
Language ENGLISH	3 Press the  button on the group 1 keypad until the following appears:
Tea water without pump	4 Press the  or the  button to change to with pump or without pump. Once the desired condition is displayed press the  button to confirm.
	5 When finished, continue to the next parameter  or press  to exit programming mode.







“Technical” Programming

Steam Boiler Pressure Regulation



Description

- This espresso machine comes with the option of either a pressure switch or a temperature probe for maintaining pressure in the steam boiler.
- The temperature probe is standard on all espresso machines. In some cases a pressure switch may be used.
- The pressure switch regulates pressure via a diaphragm type pressure switch. The pressure may be adjusted via a small screw on the switch.
- When a temperature probe has been installed the pressure in the steam boiler is regulated by adjusting the temperature of the steam boiler via the display.
- Since the temperature of saturated water is proportional to the pressure it is possible to control the pressure of the steam boiler via a temperature probe.

Display	Operating Procedure
LaMarzocco 09:30	1 Press and hold the  button on the group 1 keypad until the following is displayed (approximately 10 seconds)
Password ?????	2 Enter the 5 digit technician password using buttons 1-5 on the group 1 keypad. Once accepted the following appears:
Language ENGLISH	3 Press the  button on the group 1 keypad until the following appears:
Steam heat.Type Temp. Probe	4 Press the  or the  button to change the value to Pressure-switch or Temp. Probe then press  to confirm selection. Normally this value should not be changed
	5 When finished, continue to the next parameter  or press  to exit programming mode.
	NOTE: When this parameter is set to “Temp. Probe” an additional parameter named “Steam Temp. Cor. is activated. When changing from Temp Probe to Pressure Switch it is required to cycle power off and on through the main switch to reset the steam boiler over temperature alarm.

“Technical” Programming

Steam Boiler Temperature Correction



Description

- This parameter allows the technician to adjust the pressure of the steam boiler by raising or lowering the temperature of the steam boiler.
- This parameter is only active when the parameter “Steam heat.Type” is set to “Temp Probe”.
- The maximum permitted value for the temperature setting is 129°C.

Display	Operating Procedure
	1 Press and hold the button on the group 1 keypad until the following is displayed (approximately 10 seconds)
	2 Enter the 5 digit technician password using buttons 1-5 on the group 1 keypad. Once accepted the following appears:
	3 Press the button on the group 1 keypad until the following appears:
	4 Press the or the button to adjust the temperature higher or lower. Each block is equal to 0.9°F (0.5°C). Once the desired setting is made press the button to confirm the setting.
	5 When finished, continue to the next parameter or press to exit programming mode.

ATTENZIONE

The saturation temperature of water will vary with ambient atmospheric pressure. Tables in this manual are created for atmospheric pressure at sea level. Slight adjustment in temperature will be required for elevations other than sea level.
THE STEAM BOILER CONTAINS WATER AT ELEVATED TEMPERATURES. WATER TEMPERATURE OVER 125°C CAN CAUSE SEVERE BURNS INSTANTLY OR DEATH FROM SCALDING.







“Technical” Programming

Open Valve



Description

- This parameter allows the service staff to enable/disable the opening of the hot water valve.
- This parameter allows steam boiler depressurization.

Display	Operating Procedure
OFF 09:30	1 When the espresso machine is turned off, press and hold the  button on the group 1 keypad until the following is displayed (approximately 10 seconds)
Password ?????	2 Enter the 5 digit technician password using buttons 1-5 on the group 1 keypad. Once accepted the following appears:
Language ENGLISH	3 Press the  button on the group 1 keypad until the following appears:
OPEN VALVE DI SABLED	4 Press the  or the  button to change to ENABLE or DI SABLE. Once the desired condition is displayed press the  button to confirm.
	5 When finished, continue to the next parameter  or press  to exit programming mode.







“Technical” Programming

Drain Steam Boiler



Description

- This parameter enables the technician to enable/disable the steam boiler draining.
- This parameter allows the service staff to renew or “regenerate” the water contained inside the steam boiler, discharging about one half of the water contained in the boiler.
- This procedure is recommended in case the machine should remain inactive for more than 8 hours and in any case at least on a weekly basis.

Display	Operating Procedure
OFF 09:30	1 When the espresso machine is turned off, press and hold the  button on the group 1 keypad until the following is displayed (approximately 10 seconds)
Password ?????	2 Enter the 5 digit technician password using buttons 1-5 on the group 1 keypad. Once accepted the following appears:
Language ENGLISH	3 Press the  button on the group 1 keypad until the following appears:
Drains SteamBoil DI SABLED	4 Press the  or the  button to change to ENABLE or DI SABLE. Once the desired condition is displayed press the  button to confirm.
	5 When finished, continue to the next parameter  or press  to exit programming mode.







“Technical” Programming

Safety Valve



Description

- This parameter allows the service staff to enable/disable the safety valve test.
- This parameter allows to bring the steam boiler temperature to 140°C, thus triggering the safety valve. Once the valve has triggered disable the function.
- Should the safety valve fail to trigger within approximately one minute of the temperature reaching 140°C, disable the function and replace the valve.
- Only qualified technicians can perform this operation.

Display	Operating Procedure
OFF 09:30	1 When the espresso machine is turned off, press and hold the  button on the group 1 keypad until the following is displayed (approximately 10 seconds)
Password ?????	2 Enter the 5 digit technician password using buttons 1-5 on the group 1 keypad. Once accepted the following appears:
Language ENGLISH	3 Press the  button on the group 1 keypad until the following appears:
TEST SAFETY VALV DI SABLED	4 Press the  or the  button to change to ENABLE or DI SABLE. Once the desired condition is displayed press ther  button to confirm.
	5 When finished, continue to the next parameter  or press  to exit programming mode.

“Technical” Programming

Technician Password Assignment



Description

- This parameter allows the technician to change the password necessary to access the Technician Level Parameters (please make a note of the password as it is not resettable)

Display	Operating Procedure
	<p>1 Press and hold the button on the group 1 keypad until the following is displayed (approximately 10 seconds)</p>
	<p>2 Enter the 5 digit technician password using buttons 1-5 on the group 1 keypad. Once accepted the following appears:</p>
	<p>3 Press the button on the group 1 keypad until the following appears:</p>
	<p>4 Press the button and you will be prompted to enter the new password. Enter a new 5 digit password using a combination of the first 5 buttons on the group 1 keypad</p> <p style="text-align: center;"> </p>
	<p>5 When finished, continue to the next parameter or press to exit programming mode.</p>





“Technical” Programming

Water Volume Programming



Description

- This parameter allows the operator to program the water volume (shot volume) for the individual buttons on the keypad.
- The saved program is a number. This number relates to the number of pulses the flowmeter delivers to the CPU. Once the programmed number of pulses is received by the CPU, the flow of water is stopped.

Display	Operating Procedure
LaMarzocco 09:30	1 Press and hold the  button on the group 1 keypad until the following is displayed (approximately 10 seconds)
Password ?????	2 Enter the 5 digit technician password using buttons 1-5 on the group 1 keypad. Once accepted the following appears:
Language ENGLISH	3 Press the  button on the group 1 keypad until the following appears:
Water Volume Programming	4 Press the  button on the group 1 keypad again. The lights on the first 4 buttons will light and the light on the continuous button will begin flashing. The flashing light indicates the keypad is in programming mode While in programming mode, press any of the first 4 buttons. When the desired amount of water has been dispensed, press the same button again to stop the flow of water. Continue this same procedure for all buttons that programming is desired.
	5 Once the first 4 buttons are programmed, press the  button to exit programming mode







“Technical” Programming

Water Volume Programming



Description

- This parameter allows the operator to program the water volume (shot volume) for the individual buttons on the keypad.
- The saved program is a number. This number relates to the number of pulses the flowmeter delivers to the CPU. Once the programmed number of pulses is received by the CPU, the flow of water is stopped.

Display	Operating Procedure
	<p>6 To program the tea water dispense button, repeat procedure 1 then press the  button on the corresponding keypad that you wish to program. When the light begins to flash, press  the button. When the desired amount of water has been dispensed, press the  button again to stop the flow of water. When finished  press the button to exit programming mode.</p> <p>7 When finished, continue to the next parameter  or press  to exit programming mode.</p> <p>NOTE: The programming completed for group 1 keypad will be copied to all subsequent keypads. If other programming is desired for subsequent keypads, follow procedure 1 and 2 substituting the subsequent group keypad number for procedure 2. It is recommended to program each group separately.</p>









“Technical” Programming

Nominal Coffee Boiler Temperature



Description

- This parameter is set at the factory at a preset nominal temperature.
- The set temperature of this parameter differs from the actual temperature of the water exiting the group to the coffee.
- The temperature of the boiler is measured at the most critical point in the boiler when temperature fluctuation is the greatest.
- The temperature of the water exiting the group head is held constant by means of the mass of the group casting. Even though the temperature of the boiler may vary a few degrees, the temperature of the water exiting the group is constant.
- To set the temperature of any espresso machine it is important to measure the temperature of the water exiting the group.

Display	Operating Procedure
LaMarzocco 09:30	1 Press and hold the  button on the group 1 keypad until the following is displayed (approximately 10 seconds):
Password ?????	2 Enter the 5 digit factory password using buttons 1-5 on the group 1 keypad. Once accepted the following appears:
Groups Number 3	3 Press the  button on the group 1 keypad until the following appears:
Coffee Boilers Temperatures	4 Press the  button to select the coffee boiler you wish to change temperature.
Coffee Boiler 1 202.5°F 202.6°F	5 Press the  or the  button to change the temperature on the displayed boiler. The measured temperature appears on the left and the set temperature appears on the right side of the display. Once the desired temperature is selected press the button  to confirm the selection.
	6 Repeat procedure 5 for all subsequent boilers (if installed).
	7 When finished, continue to the next parameter  or press  to exit programming mode.







“Technical” Programming

Cup Heating



Description

- This parameter allows the user to enable or disable the cup heating routine.
- The cup heater is an option ordered from the factory, not available in the USA & Canada.
- Additional parameter settings are available in the factory level parameters under Cup Heating Times.

Display	Operating Procedure
LaMarzocco 09:30	1 Press and hold the  button on the group 1 keypad until the following is displayed (approximately 10 seconds)
Password ?????	2 Enter the 5 digit technician password using buttons 1-5 on the group 1 keypad. Once accepted the following appears:
Language ENGLISH	3 Press the  button on the group 1 keypad until the following appears:
Cup heating OFF	4 Press the  or the  button to change to ON or OFF. Once the desired condition is displayed press the  button to confirm.
	5 When finished, continue to the next parameter  or press  to exit programming mode.







“Technical” Programming

Doses Reading



Description

- This parameter allows the user to review the total doses dispensed for each button.
- The number displayed is the total number of times the individual button has been activated.

Display	Operating Procedure
LaMarzocco 09:30	1 Press and hold the  button on the group 1 keypad until the following is displayed (approximately 10 seconds)
Password ?????	2 Enter the 5 digit technician password using buttons 1-5 on the group 1 keypad. Once accepted the following appears:
Language ENGLISH	3 Press the  button on the group 1 keypad until the following appears:
Doses Reading press + or -	4 Press the  or the  button to scroll through the values for each button.
	5 When finished, continue to the next parameter  or press  to exit programming mode.







“Technical” Programming

Clock Adjust



Description

- This parameter allows the user to set the time of day and the day of the week.
- This parameter is used by the “Auto On/Off” parameter

Display	Operating Procedure
LaMarzocco 09:30	1 Press and hold the  button on the group 1 keypad until the following is displayed (approximately 10 seconds)
Password ?????	2 Enter the 5 digit technician password using buttons 1-5 on the group 1 keypad. Once accepted the following appears:
Language ENGLISH	3 Press the  button on the group 1 keypad until the following appears:
Clock adjust 09:30 Tuesday	4 The hour value should be flashing. Press the  or the  button to change the hour.
	5 Press the  button to change to minute value and again to change to the day of the week value. Follow step 3 to change these values.
	6 When finished, continue to the next parameter  or press  to exit programming mode.







“Technical” Programming

Auto On/Off



Description

- This parameter allows the user to program the espresso machine to turn on at a preset time and turn off at a preset time.
- This feature also allows the espresso machine to remain in the off condition for one repeating closed day.

Display	Operating Procedure
LaMarzocco 09:30	1 Press and hold the  button on the group 1 keypad until the following is displayed (approximately 10 seconds)
Password ?????	2 Enter the 5 digit technician password using buttons 1-5 on the group 1 keypad. Once accepted the following appears:
Language ENGLISH	3 Press the  button on the group 1 keypad until the following appears:
Auto On/Off On: ---	4 The hour value should be flashing. Press the  or the  button to change the hour for the “On” time.
	5 Press the  button to change to the minute value. Follow step 3 to change this value.
Auto On/Off OFF: ---	6 Press the  button again to change to hour value for the “Off” time. Follow step 3 to change this value.
	7 Press the  button again to change to minute value for the “Off” time. Follow step 3 to change this value.





“Technical” Programming

Auto On/Off

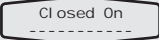

Description

- This parameter allows the user to program the espresso machine to turn on at a preset time and turn off at a preset time.
- This feature also allows the espresso machine to remain in the off condition for one repeating closed day.

Display	Operating Procedure
	<p>8 Press the  button again to change to the “Closed On” value. Follow step 3 to change this value</p> <p>9 When finished, continue to the next parameter  or press  to exit programming mode.</p>



Extra Programs [Rinsing or Back Flushing]

Pre-Programmed Rinsing (Back Flushing) Routine



Description

- This espresso machine has a group rinsing (backflushing) routine built into the electronics.
- The rinsing routine is provided to give the operator more flexibility and freedom surrounding this operation.

Display	Operating Procedure
<div data-bbox="206 642 373 685" style="border: 1px solid black; padding: 2px; text-align: center;"> Rinsing in-progress </div>	<ol style="list-style-type: none"> <li data-bbox="391 642 1596 698">1 To activate the rinsing routine, press and hold the  button, then press the  button. This activates the rinsing routine on the individual group. <li data-bbox="391 711 1596 826">2 When activated, the water pump will turn on and the electric valve, for the specific group being rinsed, will cycle on and off. There are approximately 30 cycles preprogrammed at a 4 second interval. To stop the rinsing manually, press the  button. <p data-bbox="437 839 1596 892">NOTE: To properly rinse the groups, place a small amount of cleaning detergent in a Blind portafilter basket and insert into the group to be rinsed prior to activating the rinsing routine.</p>

CAUTION

Most detergents cause foaming during the cleaning process. This foam collects at the drain box and can prohibit waste water from draining properly. Rinse only one group at a time. Rinsing multiple groups simultaneously could cause the drain box to overflow.

Troubleshooting

- This espresso machine is equipped with several feedback mechanisms that alert the operator when an unusual condition occurs. Additionally the espresso machine will warn the operator when certain parameters fall below or above the programmed point. These errors and warnings will appear as a message in the display.
- The following section will describe errors and warnings that may appear in the display

Message	Description	Message Solution
First installat. Enter to confirm	This is the first installation of the espresso machine and the CPU is asking for verification of this event.	Press the ENTER button on group 1 keypad to confirm. Then will initialize the CPU and boot the electronics.
Coffee boiler filled?	This message is displayed after the boilers have been drained. The CPU is verifying that the coffee boiler is full.	Fill the coffee boiler with water (see operating manual for detailed instructions). Ensure that all air is bled from the coffee boiler using the air bleed screw atop each group casting. The CPU will display this message to ensure that the coffee boiler is full before supplying power to the coffee boiler heating element.
Corrupted Data	This message is displayed when the CPU does not understand an instruction.	Most likely the machine power was disconnected with out first turning off the machine through the keypad and display. Turn off machine using main switch to cyclcy power on and off. This should clear the error.
Filling-up in progress	This message is displayed when the steam boiler autofill cycle is activated and water is entering the steam boiler.	No action is required when this message is displayed. This message is only displayed to notify the operator of the active process.
Filling-up Alarm	This message is displayed when the CPU does not detect a full signal from the steam boiler within the set time interval.	When this message is displayed the CPU also shuts down and turns off power to the machine (see the parameter "Level Timeout"). Press the ON/OFF button to reset this error.
Steam Boiler Empty	This message is displayed when the CPU does not receive any signal from the Safety Probe in the steam boiler.	When this message is displayed the CPU turns off power to the steam boiler heating element. The only way to reset this error is to repair the Safety Probe to restore the signal to the CPU.
Steam Boiler Temperature	This message is displayed when the steam boiler temperature exceeds the maximum allowed temperature.	When this message is displayed call an authorized service technician to repair this fault. The also CPU turns power off to the steam boiler.
Flowmeter Alarm	This message is displayed when the CPU does not receive the appropriate signal from the flowmeter.	When the flowmeter alarm is displayed, the light on the corresponding button that initiated the brew cycle will begin to flash. This problem is a result of water not flowing through the flow meter. This can be caused by the coffee packed too tightly, a blockage in the tubes, a malfunctioning water pump, a faulty valve, or a damaged flowmeter. Call a service technician to fix this problem.
Coffee Boiler 1 Heating	This message is displayed when the coffee boiler does not reach the minimum temperature with the programmed time interval.	See the parameter "Heating Timeout" for more information. The number on the display corresponds to the number of the faulty coffee boiler.
Coffee Boiler Temperature	This message is displayed when the coffee boiler temperature exceeds the maximum allowed temperature.	If this happens call an authorized service technician to repair this fault. When this message is displayed the CPU turns power off to the coffee boiler displayed. The number in the display corresponds to the faulty coffee boiler.
Autosteam 1 Temperature	This message is displayed when the autosteam temperature exceeds the maximum allowed temperature.	If this happens call an authorized service technician to repair this fault. The number in this message indicates the faulty Autosteam assembly.
Wrong Password	This message is displayed when password entered does not match the programmed password.	This error message will be displayed anytime an incorrect password is entered. The display will reset automatically after 3 seconds. Then an additional attempt may be made.



la marzocco

handmade in florence

EE - Table of Contents

EE Programming Introduction	page 66
Accessing Programming Mode	page 67
Coffee Boiler Temperature (example description for all parameters)	page 68

EE Programming Introduction

Description

- This espresso machine has a very powerful CPU and many configurable settings.
- Additionally, there are many feedback controls employed in this espresso machine to troubleshoot problems should they occur.
- The following is a brief introduction to the controls and display and how they interact with the operator.

Digital Display





The digital display (display) is a backlit display capable of displaying 2 lines of 16 characters. The display enables the operator to interact with the espresso machine to visibly change parameter values. The display also provides valuable information to the operator. There are several warnings that can be displayed to alert the operator of an unusual condition or a fault. Additionally, simple messages are displayed alerting the operator that an action has been started or that a process needs to begin.

Programming Keypad

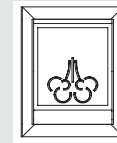
BREW BUTTON



TEA BUTTON

The first group  and the second group  buttons are used to change the values of the individual parameters. The first one increase the value, the second one decrease it. Use these button even if it's a 3 or 4 group coffee machine.



The  button is used to scroll through the menu. Additionally, this button also confirms some values within the parameters.

EE Accessing Programming Mode

EE Programming Mode



Description

- To change any configurable parameter the operator must first enter into the programming mode.
- There are two levels within the programming mode that allow the restriction of specific parameters depending upon procedure entered.

The two programming levels are as follows:

- **Barista Programming.** Limited parameters are available.
- **Factory Programming.** Barista level parameters plus additional parameters are available.

Parameters description: See the Table of Contents of AV Model

The parameters are the same of the AV Model, the only difference is the use of the push buttons as described on previous page.

Operating Procedure

Barista Level

- 1 Turn off the main-switch (0 position/ Off position)
- 2 Press and hold the tea button and turn on the main switch (1 position/On position) until the first of the following menu appears:

1 COFFEE BOILER T.

6 LANGUAGE

2 STEAM BOILER T.

7 TEMPERATURE C/F

3 CUP HEATING

8 PRE-BREWING (available from the 1.18 software version)

4 TOTAL COFFEE

9 CRONO FUNCTION (available from the 1.06 software version)

5 TOTAL TEA

10 USER NAME

When finished, scroll through the OFF parameter with the tea button and push any BREW BOTTON to turn the machine ON.

Boiler Parameters

(Barista Programming Example) Nominal Coffee Boiler Temperature



Description

- This parameter is set at the factory at a preset nominal temperature.
- The set temperature of this parameter differs from the actual temperature of the water exiting the group to the coffee.
- To set the temperature of any espresso machine it is important to measure the temperature of the water exiting the group.







Display	Operating Procedure
	1 Turn off the main-switch (0 position/ Off position)
	2 Press and hold the button and turn on the main switch (1 position/On position) until the following is displayed (approximately 10 seconds):
	3 Press the first or the second button from the left to change the temperature on the displayed boiler. The measured temperature appears on the left and the set temperature appears on the right side of the display. Once the desired temperature is selected press the button to confirm the selection and go through the menu.
	4 When finished, scroll through the OFF parameter with the button and push any button

(Factory Programming Example) Steam Boiler Level Delay



Description

- This parameter is safety feature that consider the motion of the water inside of the steam boiler.

Display	Operating Procedure
LaMarzocco 09:30	<p>1 Turn off the main-switch (0 position/ Off position)</p>
Level Probe Delay Ton: 2s Toff: 2s	<p>2 Press and hold the first  and the second  button and turn on the main switch (1 position/On position) until the following is displayed (approximately 10 seconds):</p>
	<p>3 Press the  or the  button to change the value of the parameter. When the desired value is displayed press to  confirm value.</p>
	<p>4 When finished, scroll through the OFF parameter with the  button and push any  button</p>

