

manual

strada ep 1.1

Electronically controlled gear pumps provide precise, direct pressure control. Motor speed control with La Marzocco's classic paddle interface. Absolute and direct control of pressure at any point during the extraction. Manually operated by the Barista. Record feature to program and reproduce pressure profiles.

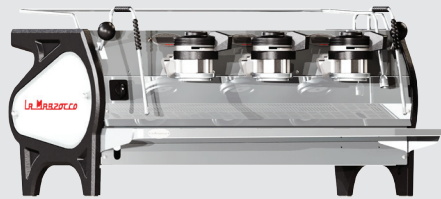

la marzocco

handmade in florence

strada ep 1.1

Operating Manual V4.2 - 06/2018
MAN.9.1.01

Chapters

| | |
|--|---------|
| 1. General Warnings and Safety Specifications | page 3 |
| 2. Definition of Available Models | page 5 |
| 3. Installation | page 8 |
| 4. Machine Operation and Coffee Preparation | page 16 |
| 5. Dispensing Steam and Hot Water | page 19 |
| 6. Maintenance and Periodic Cleaning Operations | page 20 |
| 7. De-commissioning and Demolition | page 22 |
| 8. Mandatory Maintenance and Check-up Operations | page 23 |
| 9. Software Programming Guide | page 24 |



la marzocco

handmade in florence

La Marzocco S.r.l.

Via La Torre 14/H
Località La Torre
50038 Scarperia e San Piero
(Firenze) - ITALIA

www.lamarzocco.com
info@lamarzocco.com

T: +39 055 849 191
F: +39 055 849 1990

certifications available:



1. General Warnings and Safety Specifications

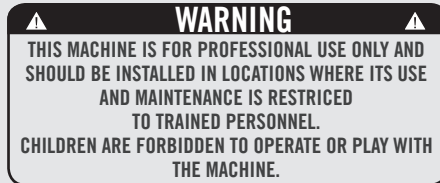

1) This operating manual is an integral and essential part of the product and must be supplied to users. Users are asked to read the enclosed warnings and cautions carefully, as they provide valuable information concerning safety during installation, operation and maintenance. This manual must be kept in a safe place and be available for consultation to new and experienced users alike.

2) Ensure product's integrity by inspecting the packaging, making sure it presents no signs of damage which might have affected the enclosed machine.

3) Check the machine's integrity after having carefully removed the packaging.
Note: In case of doubt, do not go on any further and contact your dealer or retailer immediately. They will send out specialized personnel authorized to perform service on the espresso machine.

4) Packaging (boxes, plastic bags, foam parts and whatever else) must not be left around within easy reach of children, due

to the potential danger it represents, nor be discarded in the environment.

5) Check to see that data on the rating plate corresponds to those of the main electrical supply which the machine will be hooked up to.

6) The equipment must be installed to comply with the applicable federal, state or local electrical and plumbing codes. The installation also must comply to the manufacturer's instructions, and must be performed by qualified and authorized personnel.

7) Incorrect installation may cause for injury/damages to people, animals or objects, for which the manufacturer shall not be held responsible.

8) Safe electrical operation of this device will be achieved only when the connection to the power outlet has been completed correctly and in observance of all local, national, and international electrical codes and safety regulations, and particularly by grounding the unit. Make sure grounding has been done properly as it represents a fundamental safety requirement. Ensure qualified personnel check such connection.

9) Furthermore, you must ensure that the capacity of the available electrical system is suitable for the maximum power consumption indicated on the espresso machine.

10) We do not recommend using adapters, multiple plugs and/or extension cords. If you cannot avoid using them, make sure that they are exclusively of the kind which conforms to local, national, and international electrical codes and safety regulations, being careful not to exceed the power and current ratings indicated on such adapters and extension cords.

11) This device must be used exclusively for the functions it has been designed and built for. Any other application is inappropriate and dangerous.

The manufacturer shall not be held responsible for any damages caused by improper and/or irrational use.

This machine should not be installed in kitchens.

12) Using any electrical device requires that certain fundamental rules be observed. In particular:

- do not touch the device with wet or humid hands and feet;
- do not use the device while having no shoes on your feet;

- do not use extension cords in bath or shower rooms;
- do not unplug the device from the power outlet by pulling on the power supply cable;
- do not expose the device to atmospheric agents (rain, sun, etc.);
- do not allow children or untrained people to use this device;
- do not clean the control panel with a wet cloth since it is not watertight.

WARNING
 THE COFFEE MACHINE MUST BE PLACED IN A HORIZONTAL POSITION ON A COUNTER HIGHER THAN 80 CM FROM THE GROUND.

13) Before carrying out any maintenance and/or cleaning operations, turn the main switch, which is located on the front left of the machine, to the “0” or “OFF” position, and disconnect the machine from the electrical network by unplugging the cord or by switching off the relative circuit breaker. For any cleaning operation, follow exclusively the instructions contained in this manual.

14) In case the machine is operating in a faulty manner or breaks down, disconnect it from the electrical network (as described in the preceding point) and close the water supply valve. Do not attempt to repair

it. Contact a qualified and authorized professional to perform any repair. Any repairs must be performed exclusively by the manufacturer or by an authorized centre using only original parts. Non compliance with the above could compromise the safe operation of the machine.

15) You should plan to make use of an omnipolar connector during installation, as required by local, national, and international electrical codes and regulations.

16) In order to avoid dangerous overheating problems, it is recommended that the power supply cable be fully unfurled.

17) Do not obstruct air intake and exhaust grilles and, in particular, do not cover the cup warmer tray with cloths or other items.

18) The machine's power supply cable must not be replaced by users. In case the power supply cable becomes damaged, shut off the machine and disconnect the machine from the electrical network by switching off the relative circuit breaker and close off the water supply; to replace the power supply cord, contact qualified professionals exclusively.

CAUTION
 AS ALREADY MENTIONED IN THE PRECEDING NOTES, THE MANUFACTURER SHALL NOT BE HELD RESPONSIBLE FOR DAMAGE TO OBJECTS, ANIMALS AND/OR PEOPLE WHENEVER THE MACHINE HAS NOT BEEN INSTALLED ACCORDING TO THE INSTRUCTIONS CONTAINED IN THIS MANUAL, AND IS NOT USED TO DO WHAT IT WAS DESIGNED FOR (I.E. PREPARING COFFEE AND HOT DRINKS).

WARNING
 THIS MACHINE IS NOT SUITABLE FOR OUTDOOR USE. JETS OF WATER SHOULD NOT BE USED TO CLEAN THE MACHINE, NOR SHOULD IT BE PLACED WHERE WATER JETS ARE USED.

1) Common Dimensions, Weights, and Features

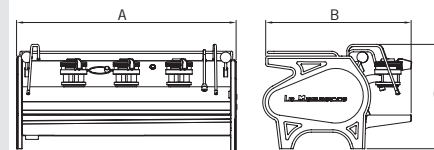

| STRADA EP | 2 groups | 3 groups |
|-------------|----------|----------|
| A [mm] | 800 | 1000 |
| B [mm] | 675 | 675 |
| C [mm] | 475 | 475 |
| WEIGHT [kg] | 70 | 91 |

2. Definition of Available Models

This operating manual refers exclusively to the following models, of our own manufacture:
STRADA 3 group Electronic Paddle: 3EP

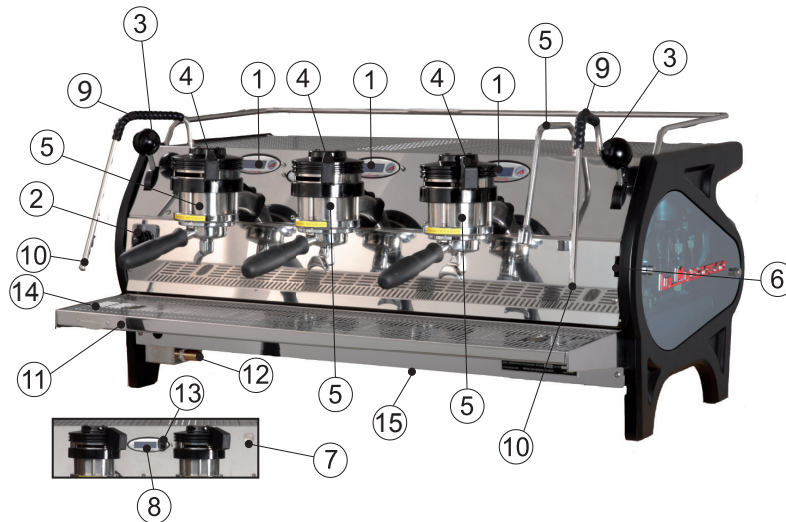

Legend

- 1 Group Display
- 2 Main Switch
- 3 Steam Wand Lever
- 4 Electronic Brew Paddle Lever
- 5 Hot Water Wand
- 6 Hot Water Mix Valve
- 7 Hot Water Switch
- 8 Programming Display
- 9 Steam Wand Protection
- 10 Steam Wand
- 11 Removable Drain Tray
- 12 Waste Water Hose Holder
- 13 Programming Jog Wheel
- 14 Drain Tray Grate
- 15 USB Key Connection

Fig. 1 - Model EP with 2 or 3 groups

For additional information on electronics, keypads, and software programming, please see the section entitled Software Programming your Espresso Machine.

1) General description

The machine is built in 2 or 3 coffee group versions and is essentially composed of the following parts:

- Steam Boiler (produces steam and hot water);
- 2 or 3 coffee boiler ("saturation")
- Brewing groups;
- Exterior Cover;
- Water pump.

2) Description of the various parts

• Steam boiler

The Steam Boiler consists of a cylindrical tank, of varying length according to the number of coffee groups, which is made of AISI 300 series stainless steel. Each unit is subjected to a hydraulic test, at a pressure of 6 bar, and has an operating pressure of 1.3-1.5 bar. The following is a list of effective volumes and power ratings according to the number of groups installed:

| | | |
|----------|-------------|------------|
| 2 groups | 8,2 liters | 3000 Watts |
| 3 groups | 11,8 liters | 4000 Watts |

Covers are welded at either end of the cylindrical tank and on one of them there is a housing for the water heating element,

which allows the steam boiler to reach operating pressure within approximately 25 minutes. Operating pressure is maintained by temperature probe and PID controller. The steam boiler has various fittings used for safety devices, for supplying hot water and steam, and for the heating element. Composed of AISI 300 series stainless steel tube. Heating is accomplished through an immersion-type plated heating element.

- Operating pressure of 1.3-1.5 bar, controlled automatically through a pressure switch or a temperature probe, adjusted to open the heating element supply circuit at 1.5 bar and close it at 1.3 bar.
- The pressure is displayed by means of a pressure gauge with a scale of 0 to 2 bar.
- Safety device, based on an expansion type mechanical valve, with counter-acting spring adjusted to 1.8 bar.
- Testing: hydraulic test at 4.5 bar performed on ready-to-use small boilers, at our factory.

• Coffee boiler

The Coffee Boiler consists of a cylindrical tank which is made of AISI 300 series

stainless steel. One each group (hot water generator for brewing coffee).

Each unit is subjected to a hydraulic test, at a pressure of 18 bar, and has an operating pressure of 9 bar. The following table is a list of effective volumes and power ratings according to the number of groups installed:

| | | |
|----------|----------------|---------------|
| 2 groups | 2 x 1,3 liters | 2 x 800 Watts |
| 3 groups | 3 x 1,3 liters | 3 x 800 Watts |

Covers are welded at either end of the cylindrical tank and on one of them there is a housing for the water heating elements. The temperature of the coffee boiler is maintained by an electronic temperature controller (PID capable) with an accuracy of 0.2°C. The brewing groups are installed on the boiler.

Composed of an AISI 300 series stainless steel tube. Heating is accomplished through an immersion-type plated heating element.

- Operating temperature 95°C (adjustable), controlled automatically by an electronic temperature controller with an accuracy of 0.2°C. Operating pressure of 9 bar, developed mechanically by a special positive-displacement pump which

is activated automatically every time coffee is brewed.

- Pressure is displayed through a pressure gauge with a scale from 0 to 15 bar.
- Safety device, based on an expansion type mechanical valve, with counteracting spring adjusted to 13 bar.
- Testing: Hydraulic test at 18 bar performed on ready-to-use small boilers, at our factory.

• **Brewing groups**

They consist of a precision casting made of stainless steel. The brewing group accepts the portafilter used to hold the ground coffee; the espresso flows through the brewing group, through the portafilter basket, through the portafilter spout, and into the cup(s) after the brewing button has been pressed.

• **Exterior cover**

It consists of a stainless sheet steel body. The structure has been the object of specific studies to provide good aesthetics, lower ergonomic costs for the operator and reduce the chance of damage to a minimum.

• **Sound pressure**

The weighted sound pressure level of the machine is lower than 70dBA.

• **Water pump**

There are two type of pump workink on this model of Strada:

- Rotary vane positive displacement pump set-up to operate anytime an electric level gauge whenever the steam boiler needs to be replenished.

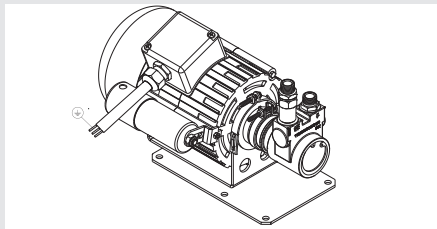

- Magnetic drive gear pump to operate whenever brewing coffee following manual or preset pressure profile from 0 to 12 bar.

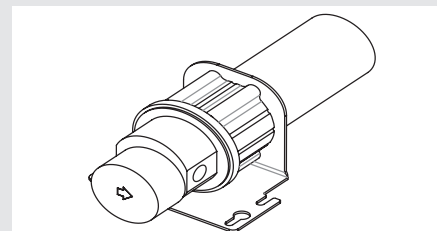

3. Installation

| MODEL/SERIES | GROUP | V/Hz | RATED POWER (W) | RATED INPUT (A) | COFFEE BOILER WATTAGE | STEAM BOILER WATTAGE | TOTAL WATTAGE | POWER CORD SIZE (mm ²) |
|--------------|-------|---|-----------------|---------------------|-----------------------|----------------------|---------------|--|
| STRADA EP | 2GR | AC220-240V/60Hz AC208-240/60Hz AC380/50Hz | 4600 | 20-22 23 12 | 1600 | 3000 | 4600 | SEE ELECTRICAL CONNECTIONS FOR DETAILS |
| | 3GR | AC220-240V/60Hz AC208-240/60Hz AC380/50Hz | 6400 | 25-29 30,5 16 | 2400 | 4000 | 6400 | SEE ELECTRICAL CONNECTIONS FOR DETAILS |

| | | |
|---|--|---|
| 3 X WIRES 220V 1 X BLUE (NEUTRAL) 1 X BROWN (PHASE) 1 X YELLOW & GREEN (GROUND) | POWER CORD: 5 X WIRES 380V 1 X BROWN (PHASE) 1 X BLUE (NEUTRAL) 1 X GRAY (PHASE) 1 X YELLOW & GREEN (GROUND) 1 X BLACK (PHASE) | WARNING THE DETAILS ON THE LEFT DESCRIBE HOW TO CONNECT EACH WIRE TO THE PLUG. RESPECT ALSO THE LOCAL SAFETY REGULATIONS. |
|---|--|---|

WARNING

THE MACHINE IS INTENDED TO BE PERMANENTLY CONNECTED TO FIXED WIRING, AND IT IS MANDATORY THAT A RESIDUAL CURRENT DEVICE (RCD) WITH A RATED RESIDUAL OPERATING CURRENT NOT EXCEEDING 30 mA IS INSTALLED.

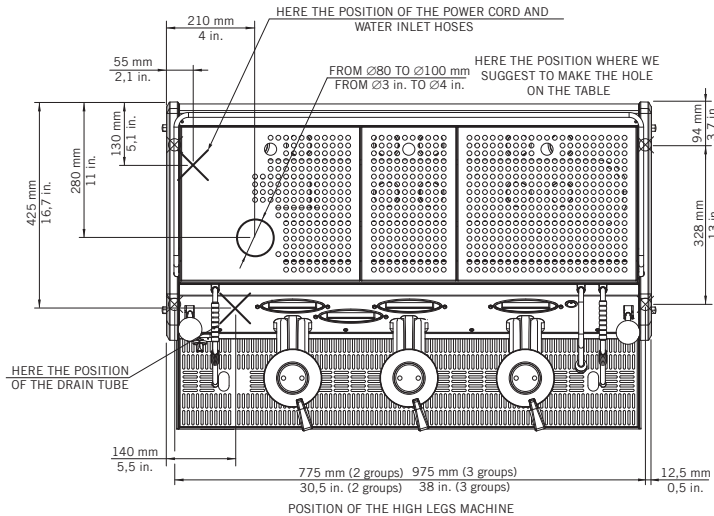

WARNING

THE COFFEE BOILER AND STEAM BOILER CONTAIN WATER AT ELEVATED TEMPERATURE. WATER TEMPERATURE OVER 125°F / 52°C CAN CAUSE SEVERE BURNS INSTANTLY OR DEATH FROM SCALDING (COFFEE BOILER 207°F/97°C-STEAM BOILER 256°F /124°C)

Fig. 2 - Installation on the counter

1) Installation guide

For best results, STRADA needs a minimum flow of water in input of 100 l/h and a pressure of 2.5 bar.

Installations that do not meet these requirements will cause a shorter life of the pump and may cause a high noise level during coffee brewing.

If the pressure and flow are not adequate, air bubbles may develop within the gears. This is called cavitation. Cavitation can impair the performance of the espresso machine.

If the incoming water of the espresso machine falls outside the recommended parameters, it is necessary to carry out one of the following installations:

Pressure lower than 3 bar Flow rate lower than 100 l/h

Installation with the rotary pump (set to 3 bar) immediately after the water treatment system, upstream of the tee.

Enter the programming menu and enable the second pump.

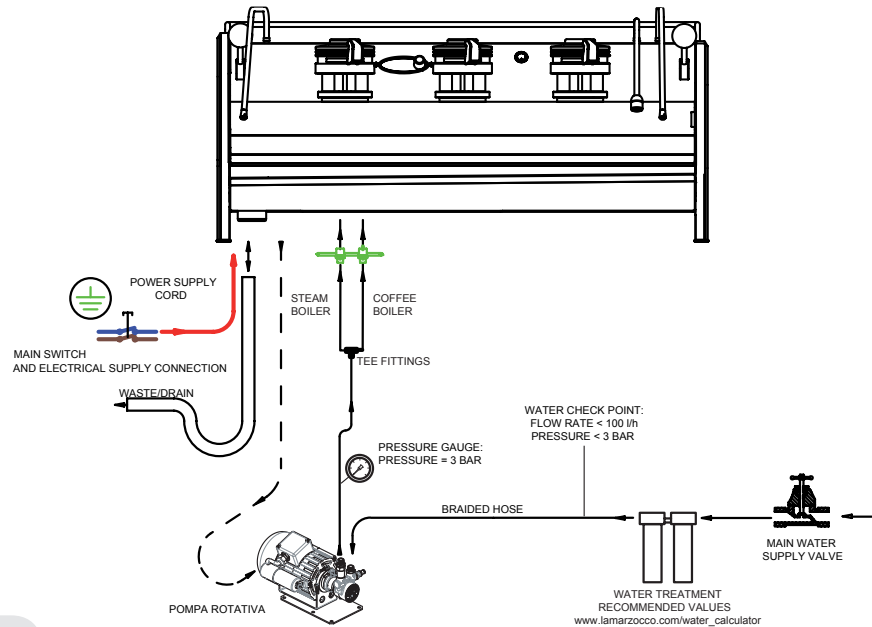

Fig. 3 - Installation guide - type 1

**Pressure higher than 3 bar
Flow rate higher than 100 l/h**

Installation of the pressure reducer (set to 3 bar with a flow rate of at least 100 l/h) immediately after the water treatment system, upstream of the tee.

Water treatment system + pressure reducer, reducing the flow rate within the recommended range NEVER LESS THAN 100 l/h.

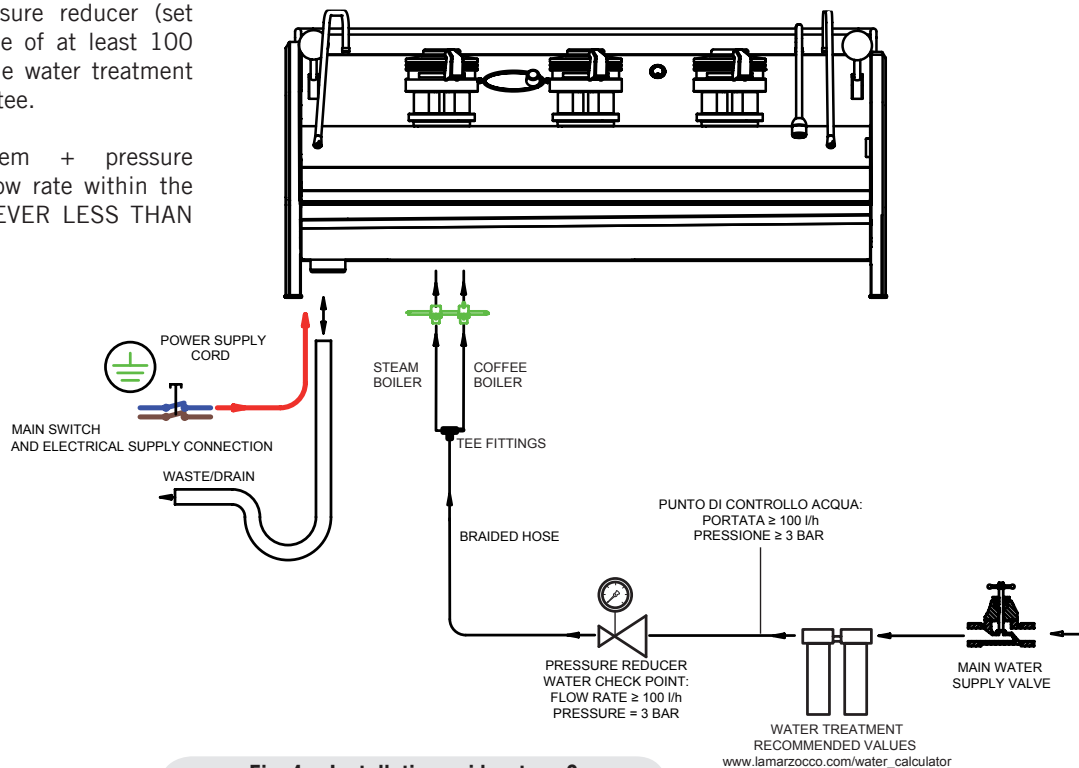

Fig. 4 - Installation guide - type 2

**Pressure higher than 3 bar
Flow rate lower than 100 l/h**

Installation of the pressure reducer (set to 3 bar) immediately after the water treatment system, upstream of the rotary pump.

Installation of the rotary pump (set to 3 bar) immediately after the pressure reducer, upstream of the tee.

Enter the programming menu and enable the second pump.

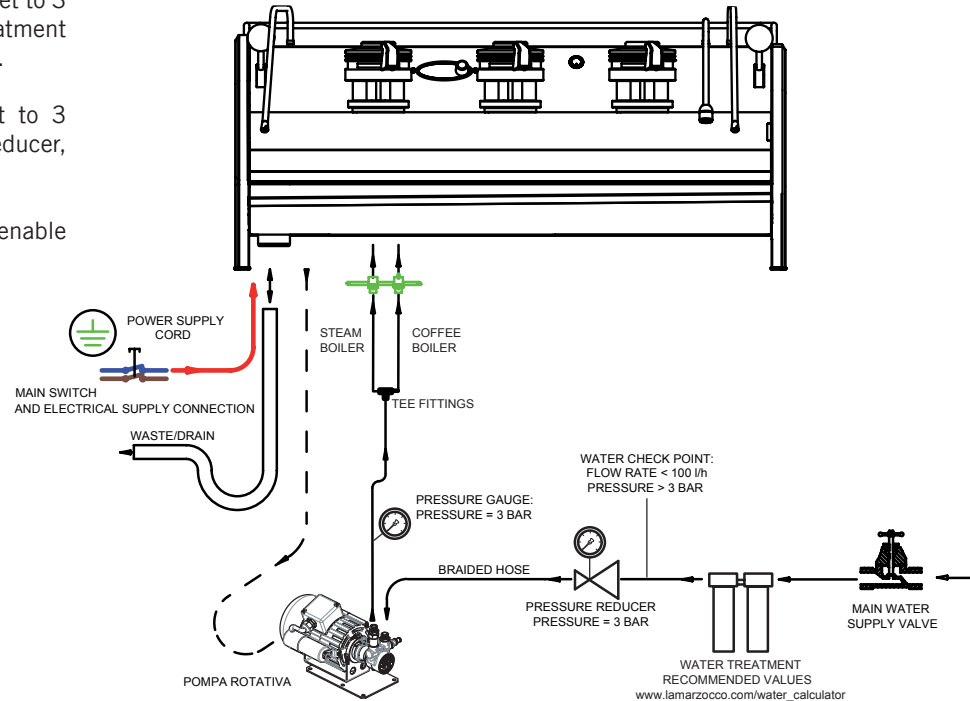

Fig. 5 - Installation guide - type 3

1) Accessories



Check the package to make sure that the following accessories are included:

- 1 x SINGLE and 3 x DOUBLE portafilters
- 2 x SINGLE and 4 x DOUBLE filters
- 1 x tamper
- 1 x blind filter
- 1 x cleaning detergent
- 3 x stainless steel braided hose for water connections
- 1 x 1,5 mt of reinforced plastic tubing for drainage
- 1 x hose clamp
- 1 x TEE Fitting

In order to proceed with installation, it is necessary that the following are available:

- Pipes carrying drinking water with a 3/8" G (BSP) end connection; (3/8" Compression for USA and Canada)
- Electrical Supply according to the specification of the espresso machine purchased:
- Single/Three phase 220VAC - 50/60 Hz electrical connection with ground, protected socket and approved interlock switch
- Single phase 200VAC - 50/60 Hz

electrical connection with ground, protected socket and approved interlock switch

- Three-phase, 380VAC - 50 Hz electrical connection with neutral + ground, near the bench on which the machine is installed and terminating in a suitable protected fivepole socket equipped with an approved interlock switch
- Waste water drain system.

Note:

- The drinking water mains valve and the circuit breakers for the electrical system need to be located in the most convenient position for the operator to access them easily and quickly.
- The machine should be placed on a flat counter and must be placed in settings with the following temperatures:
Minimum room temperature: 5°C/41°F
Maximum room temperature: 32°C/89°F
- If the machine has been temporarily housed in settings with a room temperature of less than 0°C/32°F, please contact a service technician prior to use.
- Water pressure supply must be between 0,2 and 0,6 MPa (2 and 6 bar).

2) Water test kit

In order to enable you to check if your water supply is within the suggested ranges, La Marzocco machines will be equipped with two units of a quick water test kit (see image below) including 6 test-strips and instruction cards.

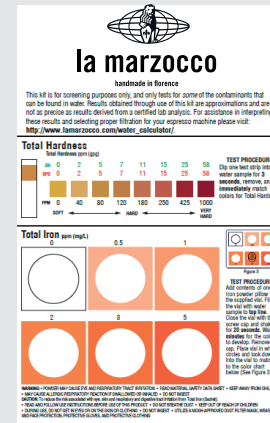

The parameters that you can measure are Total Hardness, Total Iron, Free Chlorine, Total Chlorine, pH & Total Alkalinity, Chlorides.

Ideally, you should perform a test on the water BEFORE the water treatment system and again AFTER the water system in order to verify if this is actually matching our suggested ranges.

Once the test has been performed, learn which treatment system is most appropriate

for your particular water supply by filling out the online water calculator on our website: LA MARZOCCO WATER CALCULATOR (http://www.lamarzocco.com/water_calculator/).

3) Flowmeter safety removal

Before switch on, remove the clamp from the flowmeter located inside the machine, as indicated by the adhesive label applied on the main switch. Also remove the label from the main switch.

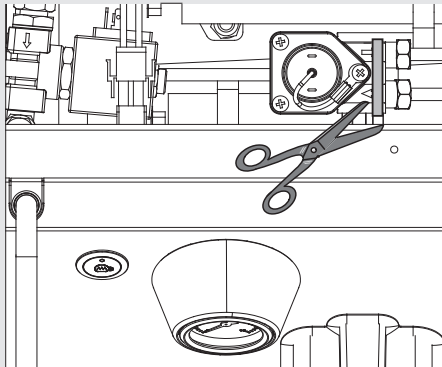

4) Water supply connection

In order to connect the machine up to the water mains proceed according to the indications given in the chapter about Installation and in compliance with any local/national safety standards of the location in which the machine is being

installed.

The equipment is to be installed with adequate backflow protection to comply with applicable federal, state, and local codes.

To guarantee a correct and safe functioning of the machine and to maintain an adequate performance level and a high quality of the beverages being brewed it is important that the incoming water be of a hardness greater than 7°f (70ppm, 4°d) and less than 10°f (100ppm, 6°d), pH should be between 6.5 and 8.5 and the quantity of chlorides be less than 50mg/l. Respecting these values allows the machine to operate at maximum efficiency. If these parameters are not present, a specific filtration device should be installed, while always adhering to the local national standards in place regarding potable water.

Then connect the inlet of the water filter/softener (if present) to the drinking water supply using one of the supplied stainless steel braided hoses. Before connecting the filter to the water pump, flush the water supply line and the filtration system in order to eliminate any residual particles which could otherwise get stuck in taps or valves thus preventing them from working properly. Connect the water supply connection of the espresso machine to

the water pump outlet using one of the supplied stainless steel braided hoses. Then connect the water pump inlet to the water filter/softener outlet (if present).

WARNING
HAZARDOUS VOLTAGE DISCONNECT FROM POWER SUPPLY BEFORE SERVICING.

WARNING
WATER PRESSURE SUPPLY MUST BE BETWEEN 4 AND 8 BAR IF SUFFICIENT PRESSURE IS NOT AVAILABLE WE SUGGEST THAT AN ADDITIONAL WATER SUPPLY SYSTEM IS USED

Note: The water pump is a differential pressure volumetric pump and has been designed to be used exclusively with cold water. Make sure that water is always present while the pump is operating, otherwise air can be introduced into the brew boiler causing an undesirable condition and the pump can be damaged.

5) Electrical connections

CAUTION
BEFORE MAKING ANY ELECTRICAL CONNECTIONS MAKE SURE THAT THE TWO STRAIN RELIEF CONNECTORS ARE FIRMLY SECURED TO THE BODY OF THE MACHINE IN ORDER TO PREVENT INADVERTENT STRESS ON THE POWER CABLES.

a) Power supply cord

- This is the main power supply cable

that provides power to the entire espresso machine. There are different types of cable based upon the electrical requirements of the espresso machine purchased:

- 200/220VAC 1 Phase 3-core cable with 4/6/10mm² cross section or AWG 12/10/8 for 2,3 4 group versions, secured to espresso machine via a strain relief connector
- 220VAC 3 Phase 4-core cable with 4 mm² cross section for 2 , 3 and 4 group versions, secured to espresso machine via a strain relief connector
- 380 VAC 3 Phase 5-core cable with 2.5mm² cross section for 2, 3 and 4 group versions, secured to espresso machine via a strain relief connector.

b) Water pump motor power cord



This is the power supply for the water pump motor. The internal electronics will switch the pump motor on when needed.

- 3-core cable with 1.5 mm² cross section or 3-core AWG 16 (for UL version) secured to espresso machine via a strain relief connector.

c) Quick connection between the water pump and the espresso coffee machine

The electrical connection must be made through the use of the connectors, as shown in the following figures:

- View of the connectors;

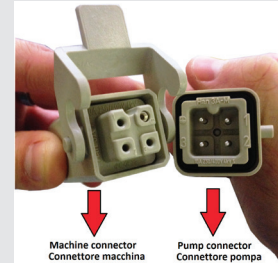

- Cable connection;

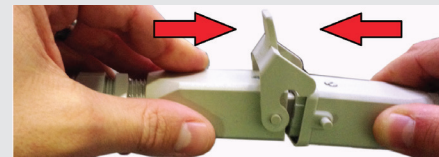

- Cable tightening;

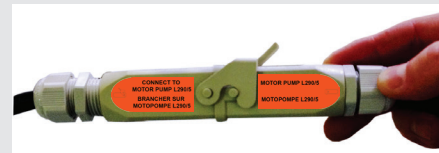

6) Waste water drain connection

The espresso machine drain is to be connected by means of the included reinforced plastic tubing. Connect one end of the reinforced plastic tubing to the drain hose connection on the left side of the espresso machine, secure with included hose clamp. Connect the other end to a suitable waste water collection system.

In case such a system is not available, drained liquids may be collected in a suitable bucket and any necessary drain pipe extensions shall be made using steel-lined PVC tubing and suitable hose clamps.

Water specifications table

| | | Min. | Max. |
|--|-------|----------|------|
| T.D.S. | ppm | 90 | 150 |
| Total Hardness | ppm | 70 | 100 |
| Total Iron (Fe ⁺² /Fe ⁺³) | ppm | 0 | 0,02 |
| Free Chlorine (Cl ₂) | ppm | 0 | 0,05 |
| Total Chlorine (Cl ₂) | ppm | 0 | 0,1 |
| pH | value | 6,5 | 8,5 |
| Alkalinity | ppm | 40 | 80 |
| Chloride (Cl ⁻) | ppm | not more | 50 |

N.B.: Test water quality (the warranty is void if water parameters are not within the range specified in the section “installation”)

▲ WARNING ▲
REPLACE FUSES WITH THE SAME SIZE, TYPE AND RATING F1 = 2A, 250V

▲ WARNING ▲
- U.S.A. AND CANADA ONLY -
DO NOT CONNECT TO A CIRCUIT OPERATING AT MORE THAN 150V TO GROUND ON EACH LEG.

▲ WARNING ▲
THE MANUFACTURER DECLINES ANY RESPONSIBILITY FOR ANY EVENT LEADING TO LIABILITY SUITS WHENEVER GROUNDING HAS NOT BEEN COMPLETED ACCORDING TO CURRENT LOCAL, NATIONAL, AND INTERNATIONAL REGULATIONS AND ELECTRICAL CODES, OR OTHER ELECTRICAL PARTS HAVE BEEN CONNECTED IMPROPERLY.

▲ WARNING ▲
IN ORDER TO PREVENT CRACKS OR LEAKAGE: DO NOT STORE OR INSTALL THE COFFEE MACHINE IN PLACES WHERE TEMPERATURE MAY CAUSE WATER IN BOILER OR HYDRAULIC SYSTEM TO FREEZE.

▲ WARNING ▲
THIS APPLIANCE IS NOT INTENDED FOR USE BY PERSONS (INCLUDING CHILDREN) WITH REDUCED PHYSICAL, SENSORY OR MENTAL CAPABILITIES, OR WITH LACK OF EXPERIENCE AND KNOWLEDGE, UNLESS THEY HAVE BEEN GIVEN SUPERVISION OR INSTRUCTION CONCERNING THE USE OF THE APPLIANCE BY A PERSON RESPONSIBLE FOR THEIR SAFETY.

4. Machine Operation and Coffee Preparation

Starting the espresso machine

a) Filling the boilers with water

Once the installation procedures have been completed, it is necessary to fill the boiler tanks with water. Complete the following procedure to properly fill the boiler tanks:

- **Coffee boiler**

The water flows inside the coffee boiler directly, as soon as the water system and water filter/softener taps (if present) are opened. Since the inflow of water will compress the air in the boiler it will be necessary to remove or “bleed” the air from the coffee boiler.

All air must be removed in order to completely “saturate” the coffee boiler/group assemblies.

To remove the air from the boiler, or “bleed the groups”, it will be necessary to remove the plastic cap and the handle from the top of the group.



Loosen the bleed screws one at a time to allow air to escape until water flows from below the screw head. Tighten the screw to stop the water from flowing. Over tightening can cause damage to the sealing washer and the group cover. Repeat this procedure on all groups.

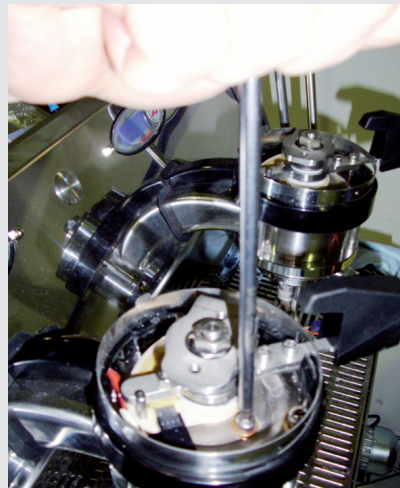

- **Steam boiler**

Turn the main switch to position “1” or ON, then push the encoder knob for three seconds and the automatic steam boiler level function will be switched on,

activating the auto-fill solenoid valve and the motor pump. This will fill the steam boiler to a predetermined level and will shut off when full.

Note: Air inside the steam boiler may build up pressure (which may be detected through the pressure gauge).

Once the pump stops, check the display, the message “Coffee Boiler Filled?” should be displayed. Push the Encoder Knob to confirm that the preceding procedures are complete.

The installation is now complete and the espresso machine should be heating to operating temperatures.

2) Waiting for the espresso machine to heat to operating temperature

During this time, it may happen that the pointer of the coffee boiler pressure reaches as high as 14-15 bar. This may happen anytime that the heating element is in the “on” condition. In this case, it is necessary to adjust the expansion valve (see the picture below about the three coffee boiler expansion valves) in such a way that the pressure never exceeds 13 bar.



In normal operating conditions, the coffee boiler pressure transducer, while brewing, can read anywhere from 0-12 bar when brewing.

The steam boiler pressure is visible through a pressure gauge placed inside the machine, behind the control and the 1st group.

When the steam boiler reaches operating temperature, the light on the Tea dispense button will switch on.

3) Brewing after first installation

Once the first installation procedures are finished, before proceeding with brewing coffee, hot water and steam, please follow these steps:

- Engage the portafilters by inserting them into each group, brew water through

each group for at least two minutes.

- Being careful to avoid burns, turn on each steam wand for at least one minute.
- Turn on the hot water valve for the time necessary to allow the following quantities of water to be brewed:
 - At least 1 liter for a 1/2 group machine
 - At least 2 liters for a 3 group machine



4) Installing the portafilters

Install the portafilter(s) by inserting them into the group and rotate the handle from left to right. When the portafilters are inserted properly, you can move the electronic Brew Paddle Lever to start the flow of water through the portafilter. You should allow hot water to pass through the empty portafilter(s) for a few seconds each time, in order to pre-heat the portafilter.

Note: It is important to leave the portafilters installed in the espresso machine when

not in use. The portafilter must remain heated for the brew process to function correctly.

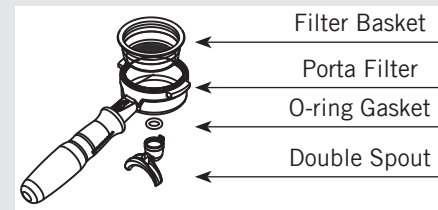

5) Brewing coffee

It is now possible to remove one of the portafilters to make an espresso beverage through the manipulation of the pressure to your taste.

The Strada Electronic Paddle is an formidable appliance for making espresso beverage that could develop extraction water pressure from 0 to 12 bar as you go.

Press down on the ground coffee with the supplied tamper and install the filter holder to the bottom of the group.

Move the paddle to begin the brewing process. As soon as you start to turn the lever placed on top of the group the magnetic drive gear pump will pushing water into the portafilter.

By turning the lever of the Electronic Paddle

it is possible to vary the speed of the gear pump, as much it will be turned as faster the pump will go.

Note: Some baristas suggest flushing the group with water to remove remaining coffee oil or particles. Some flush after every shot. Experimentation and practice is suggested to establish the best possible procedure for brewing coffee.

6) Water pump

Whenever you are brewing coffee, and you can adjust the pump pressure by turning the by-pass screw (below the plug located on the side to which the pump power supply is connected) clockwise to increase and counter-clockwise to reduce pressure. Adjust pressure only when at least one group is brewing coffee.

7) General notes for coffee preparation

The portafilters must remain heated since they are at the lowest position of the group itself, and they are partially isolated due to the rubber gasket between them. This can be accomplished by leaving the portafilters installed in the machine when

not in use. The portafilters may also be actively heated. This procedure may be carried out by brewing some hot water through the portafilter then turning off the water flow, before making coffee.

It is important to remember that coffee left over in the filters must be removed only when you need to prepare another cup, and only at that time should you place a new dose of ground coffee in the filter.

The size of the coffee granules is extremely important in preparing a good cup of coffee, other than the type of coffee mix used, quite obviously. The ideal grinding can be determined by making various coffees using the amount of ground coffee that you would normally use for each cup (we recommend at least 6-7g). The best grinding is that which allows coffee to flow out from the filter holder spouts neither too slowly (drop by drop) nor too quickly (quick light brown flow). A general rule is that a double dose should dispense approximately 25cc or 2 fluid oz. of espresso in approximately 25 seconds.

CAUTION

NEVER REMOVE THE FILTER HOLDER WHEN WATER IS BEING DELIVERED. THIS OPERATION CAN BE EXTREMELY DANGEROUS SINCE THE HIGH PRESSURE BUILT-UP INSIDE THE BLIND FILTER WOULD SPRAY OUT HOT AND SLIGHTLY CAUSTIC WATER, WHICH MAY CAUSE SEVERE BURNS. THE COFFEE BOILER CONTAINS WATER AT ELEVATED TEMPERATURE. WATER TEMPERATURE OVER 125°F / 52°C CAN CAUSE SEVERE BURNS INSTANTLY OR DEATH FROM SCALDING.

IMPORTANT

To improve the flavor of the espresso, the temperature of the water in the coffee boiler and therefore of the groups may eventually be raised or lowered via the digital display (please consult the Software Programming Manual for detailed instructions).

5. Dispensing Steam and Hot Water

1) Steaming milk or other liquids

In order to allow for any condensed water in the wand to be released ALWAYS allow some steam to be discharged by turning on the valve before inserting the steam wand into the pitcher of liquid to be heated.

Dip one of the 2 steam wands (item 10, page 5) which are connected to the steam valve, into the liquid to be heated. Move the steam wand lever gradually until steam comes out at the end of the wand.

The steam will transfer heat to the liquid raising its temperature up to boiling point. Be careful not to allow liquid to overflow in order to avoid severe burns.

In order to prevent the heated liquid from being sucked back into the steam boiler it is recommended before using the wand that you purge the steam valve and steam wand by opening the valve for a few seconds to allow steam to escape to the atmosphere from the end of the steam wand. Failure to do so can cause the heated liquid to transfer from the heated liquid container to the steam boiler

(via vacuum created from cooling parts). This condition is undesirable and can cause contamination in the steam boiler. After use remember to purge the wand by opening the steam valve for a few seconds, and then clean the outside of the wand itself with an appropriate cloth.

In order to prepare milk for making cappuccino with the right amount of foam, go through the following steps:

- After purging the steam wand place the container half-full of milk underneath, carefully open the steam valve and raise the container so as to bring the wand end to a point just below the surface of the milk; at this point, move the container up and down just enough to dip the nozzle end in and out of the milk until you get the right amount of foam, bring the temperature of the milk almost up to 149/158°F or 65/70°C. You can then pour this milk into a cup containing warm espresso and you will end up with a fresh cup of cappuccino.

2) Preparing tea and other hot drinks

TEA



You may dispense hot water by using the fixed nozzle (item 5 page 5). To dispense hot water, press the tea water button.

This button commands the hot water delivery.

The temperature of the water may be adjusted by adjusting the mixing valve.

6. Maintenance and Periodic Cleaning Operations

▲ WARNING ▲
THE MACHINE MUST BE INSTALLED SO THAT QUALIFIED TECHNICAL PERSONNEL CAN EASILY ACCESS IT FOR EVENTUAL MAINTENANCE.

▲ CAUTION ▲
THE MACHINE MUST NOT BE DIPPED IN, NOR SPLASHED WITH, WATER IN ORDER TO CLEAN IT. FOR CLEANING OPERATIONS, PLEASE FOLLOW THE INSTRUCTIONS LISTED BELOW VERY CAREFULLY.

1) Cleaning groups and drain wells

- Put a tablespoon of detergent powder for coffee machines into the blind filter, supplied with the machine, and tighten it onto the group you want to clean by using a normal filter holder.

▲ CAUTION ▲
DO NOT REMOVE THE FILTER HOLDER WHILE RELATIVE GROUP IS BREWING HOT LIQUIDS. THE COFFEE BOILER CONTAINS WATER AT ELEVATED TEMPERATURE. WATER TEMPERATURE OVER 125°F / 52°C CAN CAUSE SEVERE BURNS INSTANTLY OR DEATH FROM SCALDING.

- Turn the Paddle Valve on and off approximately 10 times (10 seconds intervals) on each group.

- Rinse the group using a normal filter, by running hot water through it several times.

2) Cleaning filters

- Put 2 or 3 teaspoons of detergent powder for coffee machines in about 1/2 a litre of water inside a heat-resistant container and boil.

- Dip filters in the boiled solution and leave them fully submerged for about 30 minutes.

- Rinse thoroughly with clean water and run hot water through one group several times with the filters in place.

- Make one cup of coffee and discard in order to remove any unpleasant flavor.

3) Cleaning filter holders (portafilters)

Using the proper cleaning tool (brush) wash the filter holders under hot water, a neutral detergent may also be used. For extraordinary cleaning see the Portafilter Manual.

4) Cleaning the drain collector

Remove the drain tray grill at least twice a week and clean, pull out the water drain collector and clean it thoroughly. Inspect and clean also the drain box and remove any leftover grounds.

5) Cleaning the body

Wipe the stainless steel surfaces with a soft, non abrasive cloth in the direction of

the glazing marks, if any. Do not use any alcohol or solvents whatsoever on painted or imprinted parts in order not to damage them.

6) Cleaning the hot water and steam nozzles

Steam nozzles must be cleaned immediately after use with a damp cloth and by producing a short burst of steam so as to prevent the formation of deposits inside the nozzles themselves, which may alter the flavor of other drinks to be heated. Hot water nozzles must be cleaned periodically with a damp cloth.

7) Cleaning the diffuser screen

- Due to filter holder discharge operations (subsequent to coffee brewing), a certain amount of coffee grounds may slowly build-up on and obstruct, even partially, the diffuser screen. To clean it, you must first remove it by unscrewing the diffuser screw.

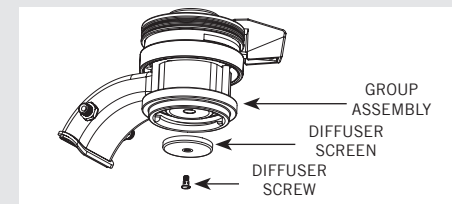

- Put 2 or 3 teaspoons of cleaning detergent for coffee machines in about 1/2 a litre of water inside a heat-resistant container and boil.
- Place the diffuser screen(s) and diffuser screw(s) in the solution and leave them fully submerged for about 10 minuti.
- Rinse thoroughly with clean water. Install and run hot water through each group several times with the screen installed.

8) Water Filter/Softener

Please see the documentation accompanying the water filter/softener for proper operating and cleaning instructions.

If the machine has not been used for more than 8 hours or, in any case, after long periods of being idle, in order to use the machine to its full potential it is necessary

to perform some cleaning cycles before brewing beverages as follows:

- **Groups:** with the portafilters engaged in the groups brew water through each for at least two minutes
- **Steam:** Being careful to avoid burns, turn on each steam wand for at least one minute.
- **Hot water:** Turn on the hot water valve for the time necessary to allow the following quantities of water to be brewed:
 - At least 1 liter for a 1/2 group machine
 - At least 2 liters for a 3 group machine
- **Steam boiler draining:** to activate this function you need to access the programming menu (see p. 41). Yearly, we recommend to fully drain the steam boiler by means of the specific drain cock located on the side of the boiler or under the boiler.

WARNING

IN ORDER TO PREVENT CRACKS OR LEAKAGE: DO NOT STORE OR INSTALL THE COFFEE MACHINE IN PLACES WHERE TEMPERATURE MAY CAUSE WATER IN BOILER OR HYDRAULIC SYSTEM TO FREEZE.

IMPORTANT

If the machine is not going to be used for long periods of time, it is advisable to follow these safety indications:

- Disconnect the machine from the water mains or interrupt the water connection via a mains tap.
- Disconnect the machine from the electrical mains.

WARNING

IF THE ABOVE-MENTIONED INSTRUCTIONS ARE NOT ADHERED TO THE MANUFACTURER CANNOT BE HELD RESPONSIBLE FOR DAMAGE TO PERSONS OR THINGS.

7. De-commissioning and Demolition

1) De-commissioning and demolition

Start by setting the main switch to the “0” or OFF position.

Disconnecting from the power outlet

Disconnect the espresso machine from the electrical network by switching off the associated circuit breaker or circuit protection device. Remove the power supply cord from the power connection. Remove the Pump Motor Power Cord from the water pump motor.

Disconnecting from the water system

Shut off the water supply by closing the specific tap located upstream of the water filter/softener inlet. Disconnect the water pipe at the water filter/softener inlet.

Remove the hose connecting the espresso machine to the water pump. Remove the reinforced plastic tubing on the drain connection.

At this point, the machine may be removed from the bar, being very careful not to drop it or squash your fingers.

The machine is made out of various materials and therefore, if you do not intend to put it back in service, it must be taken to a special disposal company which will select the materials which can be recycled and discard the others.

Current regulations make it illegal to discard such machine by leaving it on public grounds or on any private property.

Recycling notice: Warning for the protection of the environment.

Used Electrical and electronic waste contains hazardous but also valuable and scarce materials which should be recovered and recycled properly. We kindly ask that you contribute to the protection of the environment and natural resources by delivering used equipment to the relevant recycling locations if such locations are available in your country.



8. Mandatory Maintenance and Check-up Operations

These operations are in addition to the Maintenance and Periodic Cleaning Operations as specified in Chapter 6.

The following maintenance and check-up operations could be carried out by a qualified technician.
The time required for the periodic maintenance is determined by the quantity of daily work and/or coffee consumption.

N.B. These periodic maintenance operations are not covered by warranty.

EVERY THREE/FOUR MONTHS

- Replace group gaskets
- Replace diffuser screens
- Clean auto-fill probe
- Check vacuum breaker for proper operation
- Inspect water inlet valve
- Inspect drain system for leaks or clogs
- Check flow rate for each group
- Check brew temperature
- Check that brew pressure is at correct
- Check all switches for proper operation otherwise warranty is voided)
- Check filter basket condition
- Check/note water hardness (Water quality must be within the range of parameters specified in the chapter on Installation,

EVERY YEAR (in addition to the above)

- Replace portafilter baskets
- Inspect group valve plungers
- Inspect vacuum breaker
- Inspect expansion valve
- Inspect electrical wiring (safety valve) condition
- Inspect boilers safety switches
- Replace over-pressure valve
- Accurate control of the tightness at 2,4Nm of each cable on the terminal block.

EVERY 3 YEARS (in addition to the above)

Check the condition of the inside of boilers and if necessary rinse out with a proper cleaning product allowed for food and beverage appliances.

9. Software Programming Guide

Programming Introduction

| | |
|----------------------------|---------|
| Digital Display | page 25 |
| Start Up Procedures | page 28 |
| Shut Down Procedures | page 29 |
| Accessing Programming Mode | page 30 |
| Cleaning Cycles | page 31 |
| Tea Dose | page 32 |

“Barista” Programming

| | |
|---------------------|---------|
| Coffee Boiler | page 33 |
| Cup Warmer | page 34 |
| Coffee Dose Counter | page 35 |
| Clock Adjust | page 36 |
| Auto ON/OFF | page 37 |
| Offset Profile | page 38 |

“Technical” Programming

| | |
|--------------------|---------|
| Language | page 39 |
| Flow Meter | page 40 |
| Open Valve | page 41 |
| Drain Steam Boiler | page 42 |

| | |
|-------------------------------|---------|
| Safety Valve | page 43 |
| Coffee Boiler | page 44 |
| Temperature Measurement Units | page 46 |
| Total Coffee Dose Counter | page 47 |
| Filter Alarm | page 48 |
| Steam Boiler Filling | page 49 |
| Tea Brewing | page 51 |
| Tank | page 52 |
| Coffee Boiler | page 53 |
| Steam Boiler Temperature | page 55 |
| Cup Warmer | page 56 |
| Coffee Dose Counter | page 57 |
| Clock Adjust | page 58 |
| Auto ON/OFF | page 59 |
| Manual Profile | page 60 |
| Automatic Profile | page 61 |
| The STRADA Explained | page 62 |
| Pressure Profile Editor | page 63 |

STRADA Programming Introduction

Description

- This espresso machine has a CPU and many configurable settings.
- Additionally, there are many feedback controls employed in this espresso machine to troubleshoot problems should they occur.
- The following is a brief introduction to the controls and display and how they interact with the operator.

Digital Display



The digital display is a backlit display capable of displaying 2 lines of 16 characters. The display enables the operator to interact with the espresso machine to visibly change parameter values. The display also provides valuable information to the operator. There are several warnings that can be displayed to alert the operator of an unusual condition or a fault. Additionally, simple messages are displayed alerting the operator that an action has been started or that a process needs to begin.

Programming Encoder

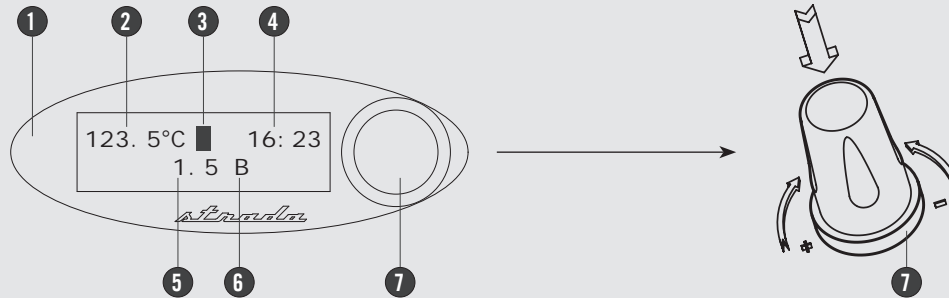

- 1 Programming display with Encoder
- 2 Steam Boiler Temperature
- 3 Heating indicator (on during heating, off when the temperature has been reached)
- 4 Daily time
- 5 Pressure inside the steam boiler
- 6 Pressure measurement unit (bar)

- 7 Encoder knob: Rotating to the right increases the value. Rotating to the left decreases the value. Pressing allows to browse the software menu, to access the functions or to confirm the first installation.

You can turn on/off the STRADA espresso machine by pressing and holding the Encoder knob for 3 seconds.

Coffee Group Display

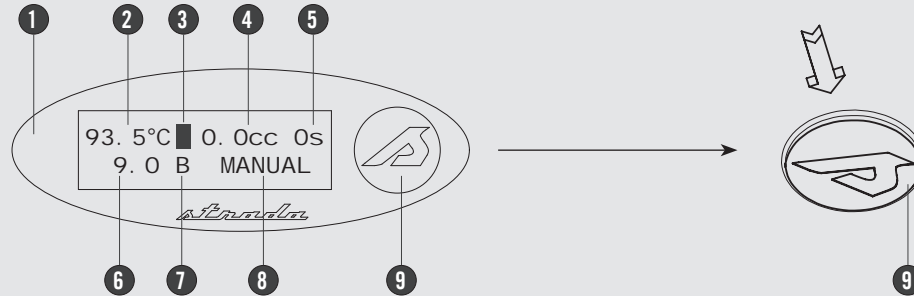

- ❶ Coffee group display (one for each group)
- ❷ Coffee boiler temperature
- ❸ Heating indicator (on during heating, off when the temperature has been reached)
- ❹ Water instant flow.
The value immediately changes and flashes when it is outside the optimum range set on page 39

- ❺ Brewing time in seconds
- ❻ Pressure inside the coffee boiler
- ❼ Pressure measurement unit (bar)
- ❽ Display of profile type (MANUAL, PROFILE 1, PROFILE 2, PROFILE 3, BACKFLUSH)

- ❾ Profile selection button: press to select the following options:
 - MANUAL
 - PROFILE 1
 - PROFILE 2
 - PROFILE 3
 - BACKFLUSH

For profile recording, see page 58.

Start Up Procedures

Turning the Espresso Machine On





Description

The following is the procedure for turning on the power to the espresso machine.

- Please follow the procedures carefully to avoid any damage to the espresso machine.

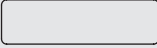
- Proceed checking for water connection to the espresso machine.
- Proceed making sure you have filled the boilers.

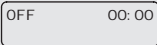
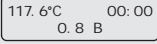
| Display | Operating Procedure |
|---|---|
| | Turn the Main Switch to the ON position. (ON=1, OFF=Ø) |
|  | 1  |
|  | 2 The message at left will be displayed briefly. This message indicates the revision level of the software installed in this espresso machine. |
|  | 3 Press and hold the Encoder Knob for 3 seconds. |
|  | 4 The espresso machine is now ON and information concerning the boiler and heating elements will appear. |



WARNING



HAZARDOUS VOLTAGE DISCONNECT FROM POWER SUPPLY BEFORE SERVICING

Shut Down Procedures

Turning the Espresso Machine Off

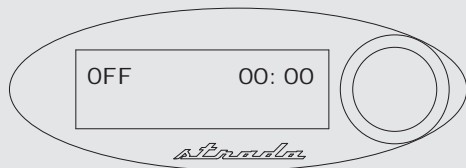

Description

The following is the procedure for turning off power to the espresso machine.

- Please follow the procedures carefully to avoid any damage to the espresso machine.

- This machine has two off settings. One setting turns off all of the components in the espresso machine and the other turns off power to the complete espresso machine.

| Display | Operating Procedure |
|---------|---|
| | <p>1 The following is the procedure for safely turning off the espresso machine.</p> |
| | <p>2 Press and hold the Encoder Knob for 3 seconds. The display changes to the following:</p> |
| | <p>3 This is the OFF setting used in the normal operating conditions.</p> |
| | <p>During servicing or other conditions that warrant it, the main switch should be turned to the OFF position. The espresso machine is off and display should be blank. It is important to follow this procedure when turning off the machine. Failure to do so can damage the electronics.</p> |
| | <p>4</p> <div style="display: flex; justify-content: center; gap: 20px;"> </div> |

⚠ WARNING ⚠
HAZARDOUS VOLTAGE DISCONNECT FROM POWER SUPPLY BEFORE SERVICING

Accessing Programming Mode

Programming Mode

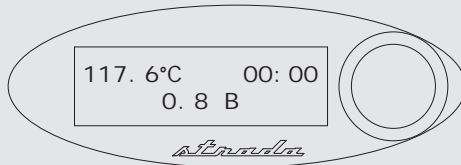

Description

- To change the values of any parameter the operator must first enter into the programming mode.
- There are two levels within the programming mode that allow the programming of specific parameters.
- The two programming levels are as follows:
 - **Barista Programming** - The parameters contained within this level are ones the operator can change to affect the quality

of the espresso.

No password is required for access.

- **Technical Programming** - The parameters contained within this level are ones the operator can change to affect the performance of the espresso machine. These parameters are set in the factory and their adjustment requires the intervention of a service technician La Marzocco recommends that no changes are made at this level.

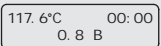
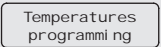
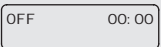
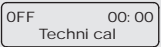
| Display | Operating Procedure |
|---|---|
| “Barista” Programming Level | |
|  | 1 While the espresso machine is on, press and hold the Encoder Knob. After approximately 10 seconds the following display appears. |
|  | 2 This is the “Barista” programming level. To set the coffee boilers, to enable/disable the resistance of the cup warmer if present, and etc.. |
| | 3 To exit the programming mode, scroll the menu, using the the Encoder Knob. |
| “Technical” Programming Level | |
|  | 1 While the espresso machine is off, press and hold the Encoder Knob. After approximately 10 seconds the following display appears. |
|  | 2 This is the “Technical” programming level. Using the Encoder Knob to move between the available parameters, press the Encoder Knob to confirm. |
| | Note: You must scroll to the end of menu to exit the programming mode |

Cleaning Cycles

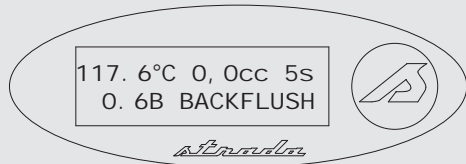

Description

- This parameter allows the operator to carry out the washing of the coffee groups, in an automatic way, by running multiple cleaning cycles.
- To run the cleaning cycle, operate the brewing lever (item 4, page 5) only once.

| Display | Operating Procedure |
|---|---|
| <p>117. 6°C 00:00 0. 8 B</p> | <p>1 When the espresso machine is on, press the button  until the following menu is displayed.</p> |
| <p>117. 6°C 0, 0cc 5s 0. 6B BACKFLUSH</p> | <p>2 Perform group washing by operating the brewing lever (item 4, page 5).</p> <p>NOTE: In order to properly rinse the groups, put a small amount of detergent in a blind portafilter basket and insert the portafilter in the group to be rinsed before activating the backflush process.</p> |

⚠ DANGER ⚠

THE COFFEE BOILER CONTAINS WATER AT ELEVATED TEMPERATURES. WATER TEMPERATURE OVER 52°C CAN CAUSE SEVERE BURNS INSTANTLY OR DEATH FROM SCALDING.

Programming Tea Dose

Tea Dose

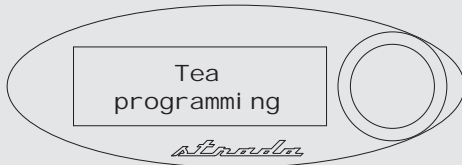

Description

- This parameter allows the operator to program the amount of water (brewing amount) for the tea button.

| Display | Operating Procedure |
|------------------------|--|
| 117.6°C 00:00 0.8 B | 1 When the espresso machine is turned on, press and hold the tea button (item 7, page 5). After about 10 seconds the following screen is displayed. |
| Tea programmi ng | 2 To set the brewing time, press the tea button to start, and then press it again to stop when the desired dose is achieved. |

Coffee Boiler

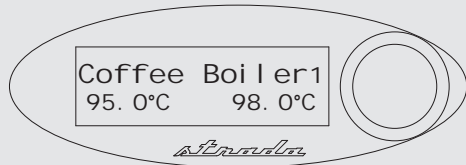

Description

- This parameter allows the operator to program the coffee boiler temperature. Each group can have a different programming.

| Display | Operating Procedure |
|---------|--|
| | 1 When the espresso machine is turned on, press and hold the Encoder Knob. After about 10 seconds the following screen is displayed. |
| | 2 Rotate the Encoder Knob to set the desired temperature, press the Encoder Knob to confirm the value. Continue with the programming of the other parameters. |
| | 3 To exit the programming mode, scroll the menu, using the the Encoder Knob. |



DANGER



THE COFFEE BOILER CONTAINS WATER AT ELEVATED TEMPERATURES. WATER TEMPERATURE OVER 52°C CAN CAUSE SEVERE BURNS INSTANTLY OR DEATH FROM SCALDING.

“Barista” Programming

Cup Warmer

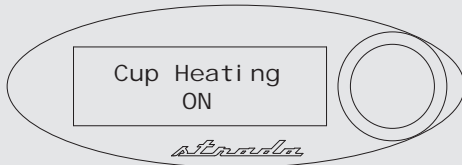

Description

- This parameter allows the operator to enable or disable the cups heating function.
- This function is displayed only on the models of espresso machine equipped with this accessory.

| Display | Operating Procedure |
|---------|---|
| | 1 When the espresso machine is turned on, press and hold the Encoder Knob. After about 10 seconds the following screen is displayed. |
| | 2 Press the Encoder Knob until the following display appears. |
| | 3 Rotate the Encoder Knob to select ON or OFF, press the Encoder Knob to confirm the option and continue with the programming of the other parameters. |
| | 4 To exit the programming mode, scroll the menu, using the the Encoder Knob. |

Coffee Dose Counter

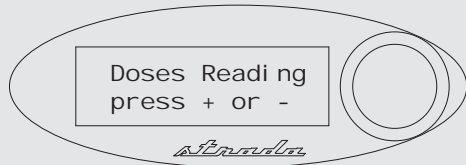

Description

- This parameter allows the operator to view the quantity of coffee and tea doses.
- This parameter displays different values:
 - Coffee doses for each group;
 - Tea doses.

| Display | Operating Procedure |
|--|---|
| <div style="border: 1px solid black; padding: 2px; margin-bottom: 5px;">117.6°C 00:00 0.8 B</div> <div style="border: 1px solid black; padding: 2px; margin-bottom: 5px;">Coffee Boiler 1 95.0°C 98.0°C</div> <div style="border: 1px solid black; padding: 2px; margin-bottom: 5px;">Doses Reading press + or -</div> <div style="border: 1px solid black; padding: 2px; margin-bottom: 5px;">Dose Group 1 8</div> <div style="border: 1px solid black; padding: 2px; margin-bottom: 5px;">Tea 1 9</div> <div style="border: 1px solid black; padding: 2px;">117.6°C 00:00 0.8 B</div> | <ol style="list-style-type: none"> 1 When the espresso machine is turned on, press and hold the Encoder Knob. After about 10 seconds the following screen is displayed. 2 Press the Encoder Knob until the following display appears. 3 Rotate the Encoder Knob to display the doses of each group and of the tea. 4 To exit the programming mode, scroll the menu, using the the Encoder Knob. |

“Barista” Programming

Clock Adjust

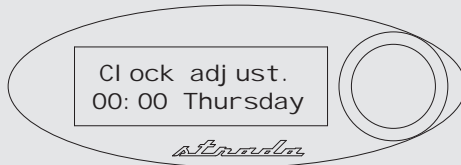

Description

- This parameter allows the user to set the time of day and the day of the week.
- This parameter is used to display time and is also used by the “Auto On/Off” parameter
- There are 3 changeable values within this parameter:
 - Hour;
 - Minute;
 - Day of week.

| Display | Operating Procedure |
|---------|--|
| | 1 When the espresso machine is turned on, press and hold the Encoder Knob. After about 10 seconds the following screen is displayed. |
| | 2 Press the Encoder Knob until the following display appears. |
| | 3 The first value will blink, use the Encoder Knob to set the clock and continue with the programming of the other parameters, press the Encoder Knob to confirm the value. |
| | 4 To exit the programming mode, scroll the menu, using the the Encoder Knob. |

“Barista” Programming

Auto ON/OFF

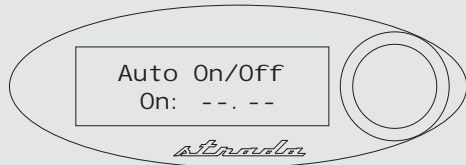

Description

- This parameter allows the operator to program the espresso machine to turn on at a preset time and turn off at a preset time.
- This feature also allows the espresso machine to remain in the off condition for one closed day.

| Display | Operating Procedure |
|---------|---|
| | 1 When the espresso machine is turned on, press and hold the Encoder Knob. After about 10 seconds the following screen is displayed. |
| | 2 Press the Encoder Knob until the following display appears. |
| | 3 If the parameter is not set the espresso machine will be always turn on, move with the Encoder Knob to set the desired time, press the Encoder Knob to confirm the value and continue with the programming of the other parameters. Repeat this operation to set the other parameters. |
| | |
| | |
| | 4 To exit the programming mode, scroll the menu, using the the Encoder Knob. |

“Barista” Programming

Offset Profile



Description

- This parameter allows the operator to set pressure profile offset.
- You can calibrate a specific offset for each available profile:
 - profile1
 - profile2
 - profile3
 - profile4

| Display | Operating Procedure |
|---------|--|
| | 1 When the espresso machine is turned on, press and hold the Encoder Knob. After about 10 seconds the following screen is displayed. |
| | 2 Press the Encoder Knob until the following display appears. |
| | 3 Rotate the Encoder Knob to set the desired value, press the Encoder Knob to confirm the value. In order to be able to set subsequent profiles, follow the same procedure. |
| | 4 To exit the programming mode, scroll the menu, using the the Encoder Knob. |

Language

Description

- This parameter allows the technician to change the language of the display.

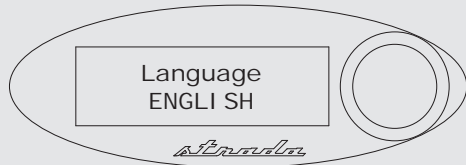

| Display | Operating Procedure |
|---------|--|
| | 1 When the espresso machine is turned off, press and hold the Encoder Knob. After about 10 seconds the following screen is displayed. |
| | 2 Releasing the Encoder Knob the following display appears. |
| | 3 Rotate the Encoder Knob to select a language, press the Encoder Knob to confirm the option. |
| | 4 To exit the programming mode, scroll the menu, using the the Encoder Knob. |

“Technical” Programming

Flow Meter

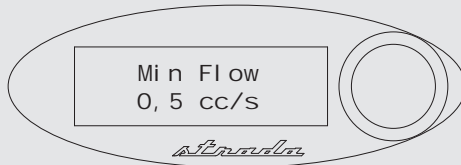

- This parameter allows the service staff to change the optimum water flow range by setting the optimum minimum and maximum value.

| Display | Operating Procedure |
|------------------------------------|---|
| OFF 00:00 | 1 When the espresso machine is turned off, press and hold the Encoder Knob. After about 10 seconds the following screen is displayed. |
| OFF 00:00 Techni cal | 2 Releasing the Encoder Knob the following display appears. |
| Language ENGLI SH | 3 Press the Encoder Knob until the following display appears. |
| Mi n Fl ow 0, 5 cc/s | 4 Turn the Encoder Knob to set the desired minimum value, press the Encoder Knob to confirm the value and move to the next menu. |
| Max Fl ow 3, 5 cc/s | 5 Turn the Encoder Knob to set the desired maximum value, press the Encoder Knob to confirm the value and move to the next menu. |
| 93, 5°C 0, 0cc 0s 9, 0 B MANUAL | 6 The display of the coffee unit displays the instantaneous flow of water. The value immediately changes and flashes when it is outside the optimum range set. |
| OFF 00:00 | 7 To exit the programming mode, scroll the menu, using the the Encoder Knob. |

Open Valve

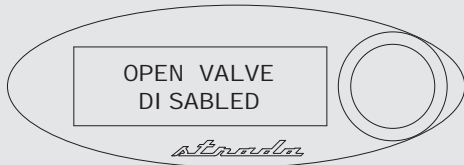

Description

- This parameter allows the service staff to enable/disable the opening of the hot water valve.
- This parameter allows steam boiler depressurization.

| Display | Operating Procedure |
|---------|--|
| | 1 When the espresso machine is turned off, press and hold the Encoder Knob. After about 10 seconds the following screen is displayed. |
| | 2 Releasing the Encoder Knob the following display appears. |
| | 3 Press the Encoder Knob until the following display appears. |
| | 4 Rotate the Encoder Knob to select ENABLED or DI SABLED, press the Encoder Knob to confirm the option. |
| | 5 To exit the programming mode, scroll the menu, using the the Encoder Knob. |

“Technical” Programming

Drain Steam Boiler

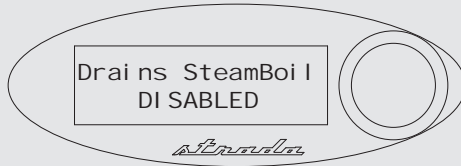

Description

- This parameter enables the technician to enable/disable the steam boiler draining.
- This parameter allows the service staff to renew or “regenerate” the water contained inside the steam boiler, discharging about one half of the water contained in the boiler.
- This procedure is recommended in case the machine should remain inactive for more than 8 hours and in any case at least on a weekly basis.

| Display | Operating Procedure |
|---------|--|
| | 1 When the espresso machine is turned off, press and hold the Encoder Knob. After about 10 seconds the following screen is displayed. |
| | 2 Releasing the Encoder Knob the following display appears. |
| | 3 Press the Encoder Knob until the following display appears. |
| | 4 Rotate the Encoder Knob to select ENABLED or DI SABLED, press the Encoder Knob to confirm the option. |
| | 5 To exit the programming mode, scroll the menu, using the the Encoder Knob. |

Safety Valve



Description

- This parameter allows the service staff to enable/disable the safety valve test.
- This parameter allows to bring the steam boiler temperature to 140°C, thus triggering the safety valve. Once the valve has triggered disable the function.
- Should the safety valve fail to trigger within approximately one minute of the temperature reaching 140°C, disable the function and replace the valve.
- Only qualified technicians can perform this operation.

| Display | Operating Procedure |
|---------|--|
| | 1 When the espresso machine is turned off, press and hold the Encoder Knob. After about 10 seconds the following screen is displayed. |
| | 2 Releasing the Encoder Knob the following display appears. |
| | 3 Press the Encoder Knob until the following display appears. |
| | 4 Rotate the Encoder Knob to select ENABLED or DI SABLED, press the Encoder Knob to confirm the option. |
| | 5 To exit the programming mode, scroll the menu, using the the Encoder Knob. |

“Technical” Programming

Coffee Boiler

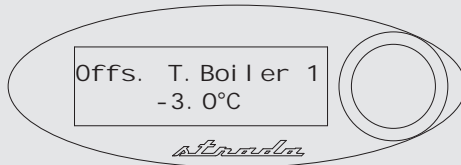

Description

- To properly calibrate the temperature of any espresso machine it is important to measure the temperature of the water exiting the group by means of an external temperature measuring device. The difference of the display temperature and the measured temperature may be compensated by use of the “Coffee T. Offset” parameter.
- The OFFSET parameter is used to calibrate the coffee boiler temperature system to ensure the display temperature

accurately represents the temperature of the water exiting the group head.

- This parameter is preset at the factory based upon initial tests of this espresso machine.
- It is not recommended that this number is changed.
- Changes to this parameter can cause unexpected results.
- It is important to write down this value before making changes to be sure you can return to the factory programming if unexpected results occur. Each machine may have a different value as it is set individually.

| Display | Operating Procedure |
|---------|--|
| | 1 When the espresso machine is turned off, press and hold the Encoder Knob. After about 10 seconds the following screen is displayed. |
| | 2 Releasing the Encoder Knob the following display appears. |
| | 3 Press the Encoder Knob until the following display appears. |
| | 4 Rotate the Encoder Knob to set the desired value, press the Encoder Knob to confirm the value. Continue with the programming of the other parameters. |
| | 5 To exit the programming mode, scroll the menu, using the the Encoder Knob. |

“Technical” Programming

Coffee Boiler

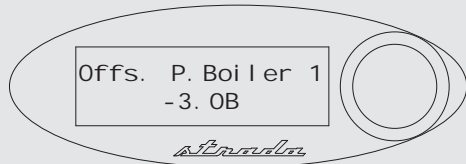

Description

- To properly calibrate the temperature of any espresso machine it is important to measure the temperature of the water exiting the group by means of an external temperature measuring device. The difference of the display temperature and the measured temperature may be compensated by use of the “Coffee T. Offset” parameter.
- The OFFSET parameter is used to calibrate the coffee boiler temperature system to ensure the display temperature

accurately represents the temperature of the water exiting the group head.

- This parameter is preset at the factory based upon initial tests of this espresso machine.
- It is not recommended that this number is changed.
- Changes to this parameter can cause unexpected results.
- It is important to write down this value before making changes to be sure you can return to the factory programming if unexpected results occur. Each machine may have a different value as it is set individually.

| Display | Operating Procedure |
|---------|---|
| | 1 When the espresso machine is turned off, press and hold the Encoder Knob. After about 10 seconds the following screen is displayed. |
| | 2 Releasing the Encoder Knob the following display appears. |
| | 3 Press the Encoder Knob until the following display appears. |
| | 4 Use the Encoder Knob to reach the value that you want to set, press the Encoder Knob to continue with the programming of the other parameters. In the case of espresso machine with 3 groups you can set the offset also on the coffee boiler 2 and 3. |
| | 5 To exit the programming mode, scroll the menu, using the the Encoder Knob. |

“Technical” Programming

Temperature Measurement Units

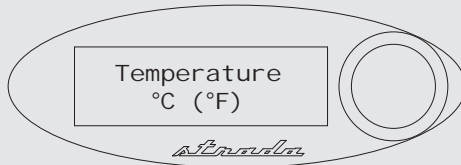

Description

- This parameter allows the technician to change the temperature display from degrees Celsius to degrees Fahrenheit and vice versa.

| Display | Operating Procedure |
|---------|--|
| | 1 When the espresso machine is turned off, press and hold the Encoder Knob. After about 10 seconds the following screen is displayed. |
| | 2 Releasing the Encoder Knob the following display appears. |
| | 3 Press the Encoder Knob until the following display appears. |
| | 4 Rotate the Encoder Knob to set the desired value and continue with the programming of the other parameters |
| | 5 To exit the programming mode, scroll the menu, using the the Encoder Knob. |

Coffee Dose Counter

Description

- This parameter allows the technician to review the total coffee doses.

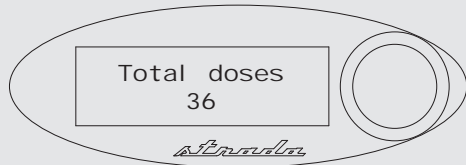

| Display | Operating Procedure |
|---------|--|
| | 1 When the espresso machine is turned off, press and hold the Encoder Knob. After about 10 seconds the following screen is displayed. |
| | 2 Releasing the Encoder Knob the following display appears. |
| | 3 Press the Encoder Knob until the following display appears. |
| | 4 This parameter displays the total coffee doses of the espresso machine. |
| | 5 To exit the programming mode, scroll the menu, using the the Encoder Knob. |

“Technical” Programming

Filter Alarm

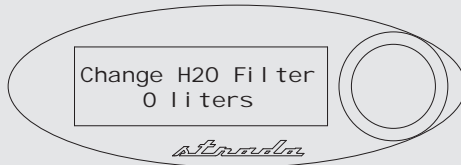

Description

- This parameter enables the technician to program an alarm that will alert the user about the need for maintenance or replacement of the water filter.
- Once the set volume has been reached, the error message “Change H2O Filter” will be displayed.
- A value of 0 (zero) disables the filter alarm parameter.
- This parameter allows the technician to set the value that will enable the espresso machine to calculate the consumption of the litres for the replacement of the water filter.

| Display | Operating Procedure |
|---------|---|
| | 1 When the espresso machine is turned off, press and hold the Encoder Knob. After about 10 seconds the following screen is displayed. |
| | 2 Releasing the Encoder Knob the following display appears. |
| | 3 Press the Encoder Knob until the following display appears. |
| | 4 Rotate the Encoder Knob to set the desired value and continue with the programming of the other parameters |
| | 5 This parameter is used to set the ratio between water and time necessary for the calculation of the replacement of the water filter. |
| | 6 To exit the programming mode, scroll the menu, using the the Encoder Knob. |

“Technical” Programming

Steam Boiler

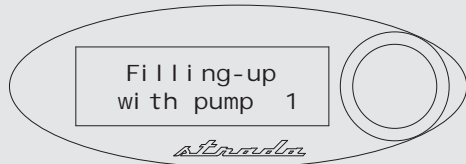

Description

- The parameter filling WITH PUMP 1 or WITH PUMP 2 allows the technician to select the activation of the water pump during the automatic filling cycle of the service boiler.
- Only under unusual circumstances would the option of “WITHOUT PUMP” be chosen.
- The electronics installed in this

espresso machine give priority to the brew boiler for pressure. The activation of the auto-fill cycle during the brewing process can reduce the overall dispensing pressure in the brew boiler.

- During the auto-fill cycle, if a brew cycle is chosen, the auto-fill cycle is delayed until all brew cycles are complete.

| Display | Operating Procedure |
|---------------------------|--|
| OFF 00:00 | 1 When the espresso machine is turned off, press and hold the Encoder Knob. After about 10 seconds the following screen is displayed. |
| OFF 00:00 Techni cal | 2 Releasing the Encoder Knob the following display appears. |
| Language ENGLI SH | 3 Press the Encoder Knob until the following display appears. |
| Filling-up with pump 1 | 4 Move lthe Encoder Knob to select WI TH PUMP 1, WI TH PUMP 2 or WI THOUT PUMP, press the Encoder Knob to confirm the option. |
| OFF 00:00 | 5 To exit the programming mode, scroll the menu, using the the Encoder Knob. |



DANGER



THE STEAM BOILER CONTAINS WATER AT ELEVATED TEMPERATURES. WATER TEMPERATURE OVER 52°C CAN CAUSE SEVERE BURNS INSTANTLY OR DEATH FROM SCALDING.

“Technical” Programming

Steam Boiler Filling

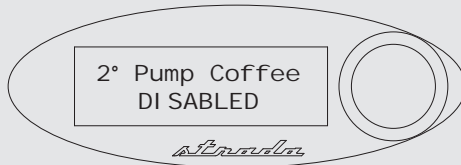

Description

- This parameter allows the technician to enable or disable the operation of the second coffee pump.

| Display | Operating Procedure |
|---------|--|
| | 1 When the espresso machine is turned off, press and hold the Encoder Knob. After about 10 seconds the following screen is displayed. |
| | 2 Releasing the Encoder Knob the following display appears. |
| | 3 Press the Encoder Knob until the following display appears. |
| | 4 Rotate the Encoder Knob to select ENABLED or DI SABLED, press the Encoder Knob to confirm the option |
| | 5 To exit the programming mode, scroll the menu, using the the Encoder Knob. |



DANGER



THE STEAM BOILER CONTAINS WATER AT ELEVATED TEMPERATURES. WATER TEMPERATURE OVER 52°C CAN CAUSE SEVERE BURNS INSTANTLY OR DEATH FROM SCALDING.

Tea Brewing

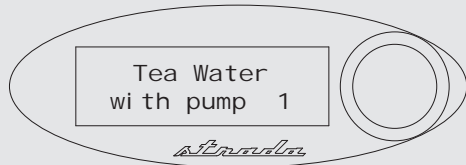

Description

- This parameter allows the technician to select the type of the tea brewing WITH PUMP 1, WITH PUMP 2 or WITHOUT PUMP.
- Only under unusual circumstances would the option of “WITHOUT PUMP” be chosen.
- The electronics installed in this espresso machine give priority to the brew

boiler for pressure. The activation of the auto-fill cycle during the brewing process can reduce the overall dispensing pressure in the brew boiler.

- During the auto-fill cycle, if a brew cycle is chosen, the auto-fill cycle is delayed until all brew cycles are complete.

| Display | Operating Procedure |
|---------|--|
| | 1 When the espresso machine is turned off, press and hold the Encoder Knob. After about 10 seconds the following screen is displayed. |
| | 2 Releasing the Encoder Knob the following display appears. |
| | 3 Press the Encoder Knob until the following display appears. |
| | 4 Rotate the Encoder Knob to select WI TH PUMP 1, WI TH PUMP 2 e WI THOUT PUMP, press the Encoder Knob to confirm the option. |
| | 5 To exit the programming mode, scroll the menu, using the the Encoder Knob. |

“Technical” Programming

Water Tank

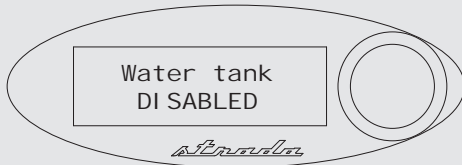

Description

- This parameter allows the service staff to enable coffee brewing through the water tank.
- This parameter is available only on the espresso machines provided with a brewing group.

| Display | Operating Procedure |
|---------|--|
| | 1 When the espresso machine is turned off, press and hold the Encoder Knob. After about 10 seconds the following screen is displayed. |
| | 2 Releasing the Encoder Knob the following display appears. |
| | 3 Press the Encoder Knob until the following display appears. |
| | 4 Rotate the Encoder Knob to select ENABLED or DI SABLED, press the Encoder Knob to confirm the option. |
| | 5 To exit the programming mode, scroll the menu, using the the Encoder Knob. |

Coffee Boiler

Description

- This parameter allows the operator to enable/disable the coffee boiler.

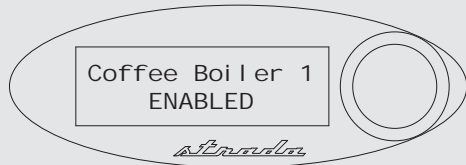

| Display | Operating Procedure |
|---------|---|
| | 1 When the espresso machine is turned off, press and hold the Encoder Knob. After about 10 seconds the following screen is displayed. |
| | 2 Releasing the Encoder Knob the following display appears. |
| | 3 Press the Encoder Knob until the following display appears. |
| | 4 Rotate the Encoder Knob to select ENABLED or DI SABLED, press the Encoder Knob to confirm the option and continue with the programming of the other parameters. Continue with the programming of the other parameters. |
| | 5 To exit the programming mode, scroll the menu, using the the Encoder Knob. |

“Technical” Programming

Coffee Boiler

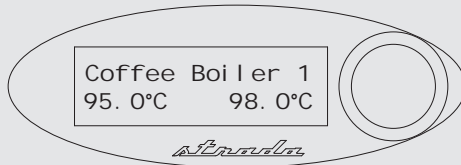

Description

- This parameter allows the operator to program the coffee boiler temperature. Each group can have a different programming.

| Display | Operating Procedure |
|---------|--|
| | 1 When the espresso machine is turned off, press and hold the Encoder Knob. After about 10 seconds the following screen is displayed. |
| | 2 Releasing the Encoder Knob the following display appears. |
| | 3 Press the Encoder Knob until the following display appears. |
| | 4 Rotate the Encoder Knob to set the desired temperature, press the Encoder Knob to confirm the value. Continue with the programming of the other parameters. |
| | 5 To exit the programming mode, scroll the menu, using the the Encoder Knob. |



DANGER



THE COFFEE BOILER CONTAINS WATER AT ELEVATED TEMPERATURES. WATER TEMPERATURE OVER 52°C CAN CAUSE SEVERE BURNS INSTANTLY OR DEATH FROM SCALDING.

“Technical” Programming

Steam Boiler Temperature

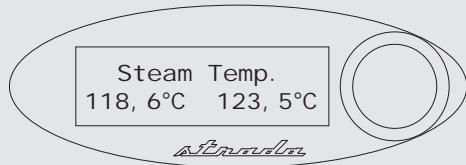

Description

- This parameter allows the operator to program the steam boiler temperature.
- The maximum permitted value for the temperature setting is 129°C.

| Display | Operating Procedure |
|---------|--|
| | 1 When the espresso machine is turned off, press and hold the Encoder Knob. After about 10 seconds the following screen is displayed. |
| | 2 Releasing the Encoder Knob the following display appears. |
| | 3 Press the Encoder Knob until the following display appears. |
| | 4 Rotate the Encoder Knob to set the desired temperature, press the Encoder Knob to confirm the value. Continue with the programming of the other parameters. |
| | 5 To exit the programming mode, scroll the menu, using the the Encoder Knob. |



DANGER



THE STEAM BOILER CONTAINS WATER AT ELEVATED TEMPERATURES. WATER TEMPERATURE OVER 52°C CAN CAUSE SEVERE BURNS INSTANTLY OR DEATH FROM SCALDING.

“Technical” Programming

Cup Warmer

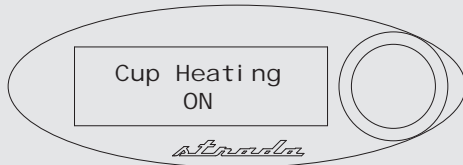

Description

- This parameter allows the operator to enable or disable the cups heating function.
- This function is displayed only on the models of espresso machine equipped with this accessory.

| Display | Operating Procedure |
|---------|---|
| | 1 When the espresso machine is turned off, press and hold the Encoder Knob. After about 10 seconds the following screen is displayed. |
| | 2 Releasing the Encoder Knob the following display appears. |
| | 3 Press the Encoder Knob until the following display appears. |
| | 4 Rotate the Encoder Knob to select ON or OFF, press the Encoder Knob to confirm the option and continue with the programming of the other parameters. |
| | 5 To exit the programming mode, scroll the menu, using the the Encoder Knob. |

Coffee Dose Counter

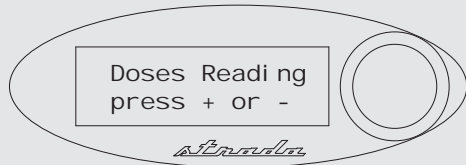

Description

- This parameter allows the operator to view the quantity of coffee and tea doses.
- This parameter displays different values:
 - Coffee doses for each group;
 - Tea doses.

| Display | Operating Procedure |
|-------------------------------|--|
| OFF 00:00 | 1 When the espresso machine is turned off, press and hold the Encoder Knob. After about 10 seconds the following screen is displayed. |
| OFF 00:00 Technical | 2 Releasing the Encoder Knob the following display appears. |
| Language ENGLISH | 3 Press the Encoder Knob until the following display appears. |
| Doses Reading press + or - | 4 Rotate the Encoder Knob to display the doses of each group and of the tea. |
| Dose Group 1 8 | |
| Tea 1 9 | |
| OFF 00:00 | 5 To exit the programming mode, scroll the menu, using the the Encoder Knob. |

“Technical” Programming

Clock Adjust

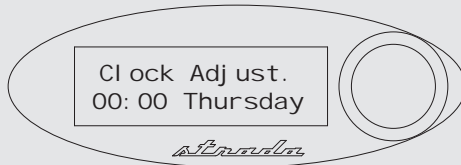

Description

- This parameter allows the user to set the time of day and the day of the week.
- This parameter is used to display time and is also used by the “Auto On/Off” parameter
- There are 3 changeable values within this parameter:
 - Hour;
 - Minute;
 - Day of week.

| Display | Operating Procedure |
|---------|--|
| | 1 When the espresso machine is turned off, press and hold the Encoder Knob. After about 10 seconds the following screen is displayed. |
| | 2 Releasing the Encoder Knob the following display appears. |
| | 3 Press the Encoder Knob until the following display appears. |
| | 4 The first value will blink, use the Encoder Knob to set the clock and continue with the programming of the other parameters, press the Encoder Knob to confirm the value. |
| | 5 To exit the programming mode, scroll the menu, using the the Encoder Knob. |

Auto ON/OFF

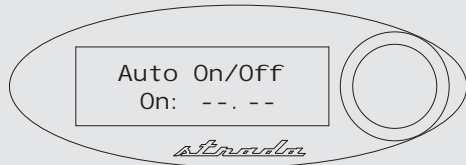

Description

- This parameter allows the technician to program the espresso machine to turn on at a preset time and turn off at a preset time.
- This feature also allows the espresso machine to remain in the off condition one closed day.

| Display | Operating Procedure |
|---------|---|
| | 1 When the espresso machine is turned off, press and hold the Encoder Knob. After about 10 seconds the following screen is displayed. |
| | 2 Releasing the Encoder Knob the following display appears. |
| | 3 Press the Encoder Knob until the following display appears. |
| | 4 If the parameter is not set the espresso machine will be always turn on, move with the Encoder Knob to set the desired time, press the Encoder Knob to confirm the value and continue with the programming of the other parameters. Repeat this operation to set the other parameters. |
| | |
| | |
| | 5 To exit the programming mode, scroll the menu, using the the Encoder Knob. |

“Pressure Profile” Programming

Manual Profile

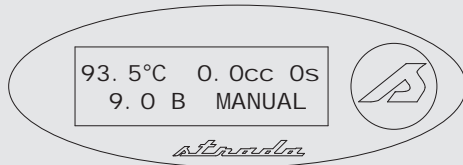

Description

- This function allows the operator to manually brew the coffee, varying the water pressure on the coffee.

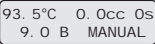
| Display | Operating Procedure |
|---|---|
|  <p>93.5°C 0.0cc 0s 9.0 B MANUAL</p> | <ol style="list-style-type: none"> <li data-bbox="363 636 1527 685">1 When the espresso machine is on and with the parameter set to MANUAL, you can brew the coffee dose by actuating the brewing lever (item 4, page 5). <li data-bbox="363 715 1527 742">2 To stop the brewing of the coffee dose, it is necessary to bring the dispensing lever back to the home position. |

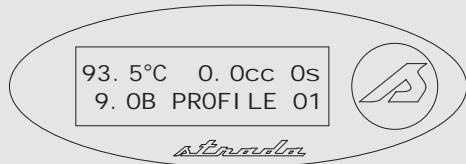

“Pressure Profile” Programming

Automatic Profile



Description

- Four different profiles are factory set (see also the contents of the USB stick).
- This function allows the operator to store four different pressure profiles, overwriting those already set at the factory.

| Display | Operating Procedure |
|--|---|
| <p>93.5°C 0.0cc 0s 9.OB PROFILE 01</p> | <p>1 When the espresso machine is on and with the parameter set to PROFILE, you can store the pressure profile.</p> |
| <p>93.5°C 0.0cc 0s 9.OB PROFILE 01</p> | <p>Press and hold the button  on the group where you want to store the pressure profile, then PROFILE No. will flash on the display. Now the machine is ready to be set.</p> <p>2 At the end, press the button again . The machine is ready to repeat the profile.</p> <p>All the profiles that will be set with this procedure on the 1st group will be repeated on the others.</p> |

The STRADA Explained

A Few crucial facts you should understand before operating the machine.

The STRADA is a powerful tool which acts very differently, when compared with other espresso machines.

Let's consider all the main differences one by one:

Temperature: the display of the STRADA shows you a value that is an assumption of the temperature of the water flowing through the coffee puck.

However the thermocouple is placed in the boiler (and not in the group), very close to both the heating element and the water inlet. This is the most volatile part of the boiler and is both the coolest and hottest point.

Since the probe sits in the most inconsistent spot, the CPU reacts faster and more precisely depending on the temperature changes, thus making the machine perform more consistently.

Still the temperature at the group is estimated by setting a default -3°C offset on the actual probe reading. Therefore, if the operator sets the temperature at 96°C, the display will show 93°C.

Pressure: as with the temperature, the displayed pressure on the STRADA is the

actual pressure on the coffee puck and not the pressure at the pump, (as in ALL other espresso machines). This explains why the display shows low-pressure readings when the group is flushed with no portafilter or coffee packed in the basket.

The coffee puck itself is making the pressure build up, depending on its permeability and resistance. This is controlled by the operator through adjustments in grinding, dosing and tamping.

How the STRADA follows a defined pressure profile:

Each group of the STRADA has a dedicated 24V DC gear pump, which spins at a variable speed, dispensing variable water flow-rate and pressure.

The operator controls the pump's speed/pressure through a paddle that activates a potentiometer, which sets the voltage sent to the pump.

When the STRADA follows a set profile, the CPU reads a pressure that is very close to that in the coffee puck, therefore it is very susceptible to minor changes in grinding, dosing and tamping.

If, for instance, the operator tamps slightly weaker, or packs in the basket a smaller quantity of ground coffee, the water will encounter less resistance in its path,

therefore the pump will have to spin faster (consequently delivering more water) in order to reach the set pressure.

This will result in a totally different cup of espresso.

In order to avoid this effect, it is crucial to weigh/dose the ground coffee in the basket accurately, and to calibrate the tamping pressure, either by using dynamometric tampers or tamping on a scale.

Volume: STRADA version 1.1 allows to check the water flow in real time rate during extraction, which is displayed in cc/sec, and to set an extraction volume, like in ordinary dose-based machines.

If you enable the "volume check", the set volume will always have priority over the pressure profile and the extraction time.

If the amount of ground coffee in the filter is smaller, for example, or if it is more loosely pressed, the machine will automatically stop once the desired volume is reached, earlier than specified in the profile.

Conversely, if the amount of ground coffee in the filter is greater, or if it is more tightly pressed, the time specified in the profile will be prolonged until the set dose is reached, holding the last recorded pressure for the extra seconds required to get the desired volume inside the cup.

Pressure Profile Editor

System requirements

The Strada EP Profile Editor allows you to create and edit pressure profiles for your Strada EP. After creating profiles on the computer, you can download them to your Strada EP by using a USB memory key.

The Strada EP Profile Editor web application can be used with Google Chrome (v34 and higher) and Mozilla Firefox (v30 and higher) on both Windows and the Apple OSX operating system. Safari and Internet Explorer are not supported by the web application at this time.

There is also a desktop version of the Strada EP Profile Editor which can be used on Windows (Vista and higher) and Apple OSX (10.5 and higher)

Installation of desktop application

Usage of Web Application

To access the web application, visit <<http://profileeditor.lamarzocco.com>>. If you already have an account, you can login to the application. If not, you must create an account.

Creating an account

To create an account, click on the “Sign Me Up” button on the login screen. You must provide your e-mail address, your name, and your password to create an account. Note that it is only possible to have one account for each e-mail address.

Create a Profile

After you login to the application, you will be taken to the main profile screen. On the right side of this screen is your Profile Library. This contains all of the Strada EP Pressure Profiles that you create. It starts with 4 default profiles provided by La Marzocco.

To view a profile, you can click on it from the right side Profile Library. It will then show up in the main section of the screen so you can edit it.

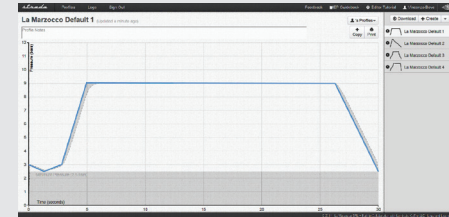

To create a profile, click on the “Create” button in your Profile Library. This will create a new profile, which you can edit. You can change the name of the profile by clicking on the name at the top of the screen. Points can be added to the profile by clicking in the graph section. You can select one point by clicking on it or more than one point by holding the shift button while selecting points. Once selected, points can be dragged using the mouse or the up, down, left, and right keys on the keyboard. They can also be deleted using the “Delete” button or the delete key on your keyboard.

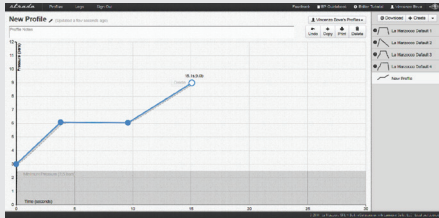

Loading a Profile from a COF file

It is also possible to load files that have been previously saved as a COF file, either by manually programming them on the Strada EP or by downloading from the application. To access this functionality, click on the dropdown next to the Create button and select the “Load Profiles (.COF)” option.

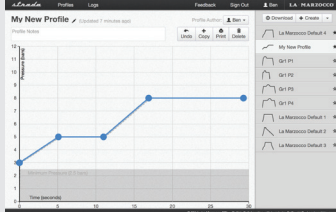

After selecting a file, you will have new profiles in your library. These will be named Gr1 P1, Gr1 P2, Gr1 P3, and Gr1 P4. You can rename these profiles by editing them and changing their names.

Managing your Profile Library

The profile library contains all of the profiles that you create. They are sorted in alphabetical order. If you would like to make some profiles easier to find in the library, you can “favorite” them by clicking on the star to the right of each profile. The starred profiles will be placed at the top of your profile library. To unfavorite a profile, just click on the star again.

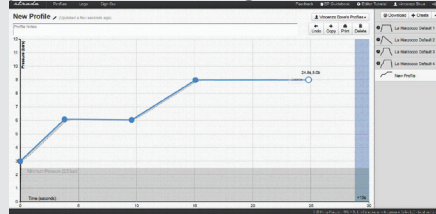

You can also delete a profile by selecting the profile and clicking the Delete button. If you would like to duplicate a profile, you can click the Copy button. This will make a new profile which has the same name except that it starts with “Copy of”.

Downloading Profiles

Profiles are loaded onto the Strada EP by save COF files onto a USB memory stick and inserting that into the Strada EP’s USB port. Once you have created profiles that you would like to load onto your Strada EP, click on the “Download” button

in your Profile Library. This will show a download pane which allows you to select which profiles you would like to download.

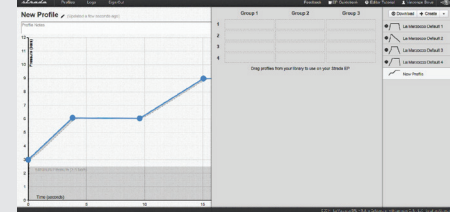

The download panel lets you drag profiles to be used as Profile 1, Profile 2, Profile 3, and Profile 4 on Group 1, Group 2, and Group 3. To add a profile to a particular group, drag the profile from your library onto the slot you would like to use it in.

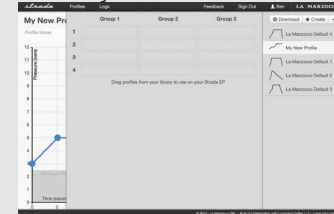

In this example, we have dragged La Marzocco Default 4 to slot 1 on Group 1 and My New Profile onto slot 2 of Group 1. Since many baristas like to have the same profiles on all of their groups, profiles that are placed in Group 1 are automatically loaded onto Groups 2 and 3. To override

this, simply drag a different profile to one of those slots on Group 2 or 3.

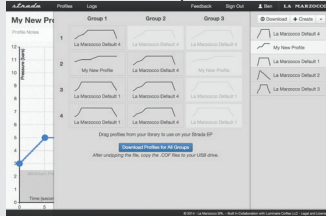

Once you have loaded 4 profiles selected for each group, you will be able to download the profiles by clicking on the Download Profiles button. This will download a ZIP file which contains the COF files for Group 1, 2 and 3. If the download button is not working, make sure that you are using a supported browser. This action will not work in Internet Explorer or Safari.

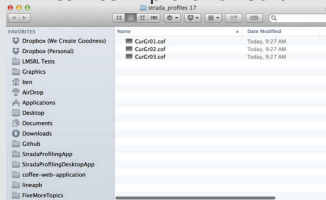

Once you unzip the file you download, you should see three files named “CurGr01.cof”, “CurGr02.cof” and “CurGr03.cof”. These contain the profiles for Group 1, Group 2, and Group 3 respectively. Load these files onto your USB key. It

is important that you do not change the names of these files!

USB key specification (note like “format usb before using”)

Load profiles on the machine

Offline Mode

It is possible to use both the desktop and web application in “Offline Mode”. To use the web application in offline mode, simply visit the same URL when you do not have a connection to the Internet. You will see your profile library and be able to use the application as if you were connected to the internet, including creating, editing, and downloading profiles. You are not able to edit your account information when offline. Any time you edit a profile, that profile will be marked with an icon in your profile library. This means that there are changes to this profile which have not been saved to the server. These will be automatically synchronized with the server if you load the application when you have an internet connection or when you click the “Offline – Sync Now” button.

In order to use the offline mode, you need to have visited the application previously

in the same web browser. By default, the offline mode will load the library of the person who most recently logged in. For security purposes, if you do not want your profile library accessible in offline mode you must “Log Out” of your account. If you do Log Out of your account, your profile library will not be accessible offline.

The copy of your profile library used in offline mode is whatever your web browser on that computer most recently accessed. If you use the application on multiple computers, keep in mind that the offline mode might not have your latest profiles if you made changes more recently on a different computer.

Change Password and Deleting Account

If you forget your password, you can reset it by clicking on the “Forgot Password” link on the login screen. This will send an e-mail with a confirmation code to your registered e-mail account. From here you will be able to reset your password.

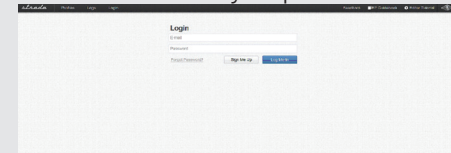

If you are logged into the application, you can change your password or name by clicking on your name in the top right. It is

